

# Battery Charger/Simulator and DC Power Supply

## BCS Series



### Features and benefits

- Source or sink up to 150 W with 2-quadrant operation
- Dual channel and dual range operation (BCS6401 only)
- Perform battery charge, discharge, cycling, and simulation tests
- Bidirectional capabilities in battery mode to simulate a rechargeable battery
- Sink current up to 5 A
- Bipolar output
- Variable output impedance 0 Ω to 1 Ω
- Fast load recovery time < 30 μs to minimize overshoot
- Linear regulation with low noise < 3 mVpp
- High 100 nA current readback resolution
- List programming: Save 20 list mode programs with up to 30 steps each into internal memory
- Internal storage for 20 user-configurable battery charge and simulation profiles with up to 40 steps each
- 4.3-inch color TFT display
- Rear panel digital voltmeter (DVM)
- Rear output terminals with remote sense
- Min, max, mean, and peak statistics
- USB (USBTMC-compliant) and LAN interfaces supporting SCPI commands
- Overvoltage (OVP), overcurrent (OCP), overtemperature (OTP) protection, and key-lock function

The BCS6401 and BCS6402 battery charger/simulator and precision DC power supplies are optimized for testing batteries and battery-operated devices. Both models feature source/sink capabilities, a bipolar output, and variable output impedance to charge, discharge, or simulate batteries used in portable and wearable electronic devices.

Device manufacturers and design engineers are typically required to evaluate their products under a variety of battery conditions including different capacity and internal resistance levels. In simulator mode, the BCS Series offers control over these conditions with configurable capacity, voltage, and resistance (IR) points to evaluate device behavior under various simulated battery conditions.

The battery function can be set to charge, discharge, or simulator mode. In charge mode these instruments source power with configurable stop conditions. The output can be configured to provide electrical isolation from connected batteries preventing parasitic drain when charging is complete. In discharge mode, these instruments act as a load to sink power up to 150 W. These two modes are useful for battery charge-discharge cycle testing or evaluating charger circuits under load.

This series also serves as a precision DC power supply with exceptional transient response times, high current readback resolution, and low ripple/noise characteristics due to its linear design. To handle rapid load changes, the fast output speed setting optimizes transient response time while minimizing overshoot and output recovery time. The single channel model delivers up to 150 W of output power while the dual channel model offers up to 45 W per channel or 90 W combined.

Model	BCS6401		BCS6402
Channels	2		1
Voltage		CH1	CH2
	High	± 15 V	0 to 15 V
	Low	± 9 V	0 to 9 V
Current (Source / Sink)	High	3 A	
	Low	5 A	
Power	45 W per channel		150 W

### Applications

The BCS Series' charge/discharge and simulation features help accelerate battery design and development of portable electronic devices with application areas including:

- Cell phones, tablets, wearable devices, and other IoT devices
- Chargers and charger circuitry
- DC-DC converters

## Operation Highlights

The BCS Series features two main operating modes: Source and Battery. In source mode, the instrument operates as a conventional DC power supply, whereas battery mode provides battery charge, discharge, and simulation capabilities. These two operating modes are enhanced with additional features including list programming for generating test sequences, graphical data logging, and math functions.

### Battery charge

Both models are well suited for charging batteries and feature a configurable output-off state to prevent drain of connected batteries when charging is complete. Setting the output-off state to Relay off internally disconnects the power supply output using a built-in relay which provides an isolation impedance > 1 GΩ. Other output-off states include high impedance, normal, and zero.

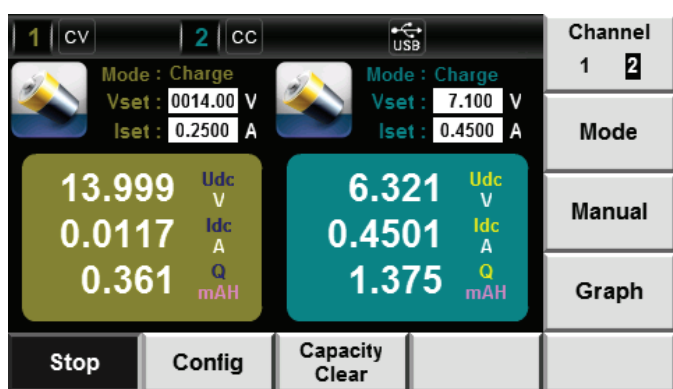

BCS6401 Battery Charge Set Up

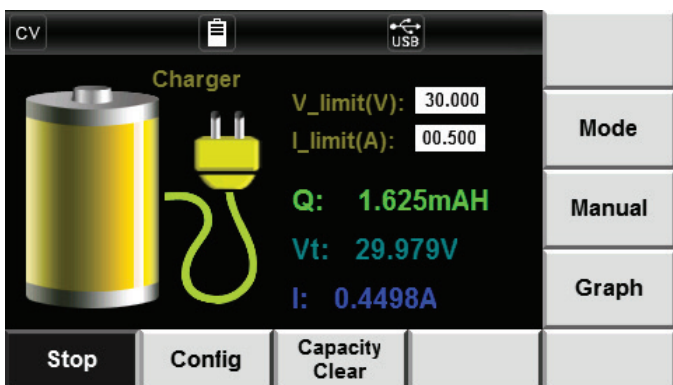

BCS6402 Battery Charge Set Up

Set a variety of battery charge parameters and stop conditions to protect the power supply and the battery.

Charge stop conditions:

- Voltage shut off
- Current shut off
- Capacity shut off (mAh)

Charge parameters:

- Charge voltage limit (Vset)
- Charge current limit (Iset)

### Battery discharge

In battery discharge mode, the BCS6401 and BCS6402 act as a load to discharge batteries typically found in portable electronic devices.

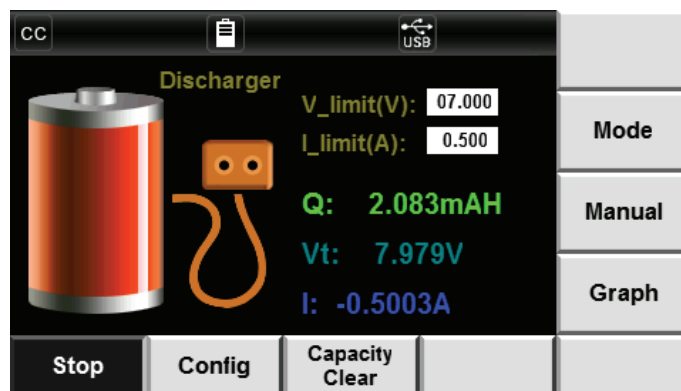

BCS6402 Discharge Set Up

- Set discharge voltage and discharge current
- Battery capacity is monitored and displayed during the discharge test

### Dual-channel model special application

Battery test and evaluation practices typically involve the repeated charging and discharging of batteries also known as charge-discharge cycle testing. The dual channel BCS6401 is well suited to perform charge-discharge tests by setting CH1 to charge a battery and CH2 to discharge another battery simultaneously.

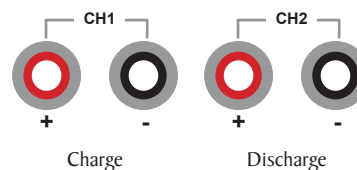

## Operation highlights (cont.)

### Battery simulation

Rather than having to rely on the uncertainty and variables of a physical battery, the BCS Series can simulate the output of a physical battery where internal resistance (IR) can be adjusted from 0  $\Omega$  to 1  $\Omega$  with 1 m $\Omega$  resolution. This feature is especially useful for testing battery powered devices at various combinations of battery charge states, voltages, and internal resistance levels. Having control over these battery parameters offers repeatable results and allows users to jump directly to different battery charge states and conditions.

During battery simulation, the BCS6402 displays the following battery parameters:

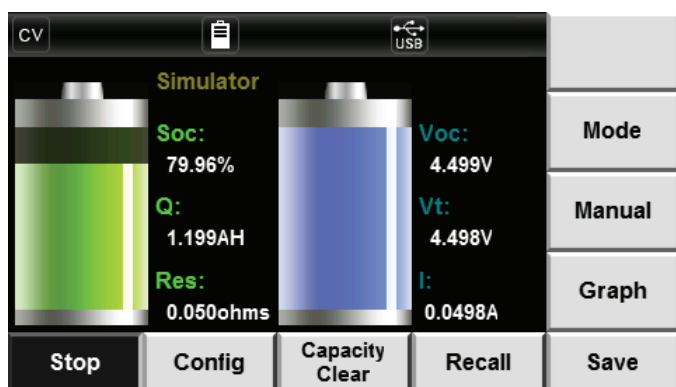

- Capacity in percent %(Soc)
- Capacity in mAh (Q)
- Battery internal resistance (Res)
- Open-circuit voltage (Voc)
- Terminal voltage (Vt)
- Charge / discharge current (I)

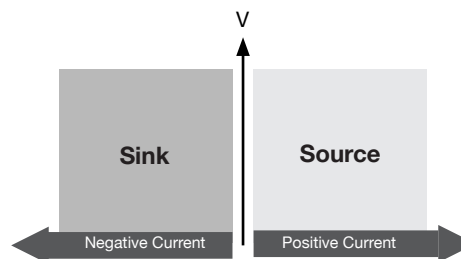

Both models are capable of sourcing power or sinking power in battery simulation mode.

Sink up to 5 A of current continuously and power up to 45 W per channel using the BCS640I or up to 150 W with the BCS6402.

### Battery simulation profiles

Battery simulation is based on a set of user-defined battery characteristic steps including capacity (mAh), voltage (V), and resistance ( $\Omega$ ).



- Create and edit simulation profiles from the front panel
- Save/recall a maximum of 20 battery simulation profiles with up to 40 steps each

Alternatively, battery test profiles can be created on a PC in spreadsheet format and imported using the front panel USB host port.

	A	B	C
1	Capacity	Voltage	Resistance
2	1200	4.2	0.05
3	1000	4.1	0.1
4	500	3.8	0.2
5	250	3.75	0.25
6	100	3.7	0.3



Save battery simulation profiles as a .CSV file for import

## Applications

### Battery simulation application

Evaluate your device under test (DUT) in its different operating conditions by monitoring both the device and simulated battery under various charge states. For example, monitor small current changes when the device is active or in sleep mode with 100 nA resolution.

When connected to the DUT's battery terminals the BCS Series provides repeatable battery simulation features:

- Jump directly to specific charge states to verify device performance from fully charged to low-battery scenarios.
- Monitor DUT behavior at various simulated battery internal resistance (IR) levels.
- Eliminates the need for a physical battery where SoC, exact battery voltage, and battery internal resistance conditions are not easily controlled.

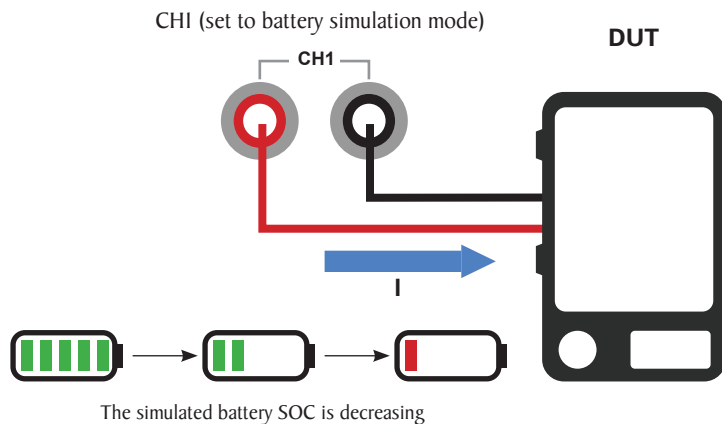

### Charge circuit testing application

Bidirectional capabilities in battery simulation mode allow the BCS Series to absorb power and simulate a rechargeable battery. This is useful for verifying the DUT's charger circuit performance.

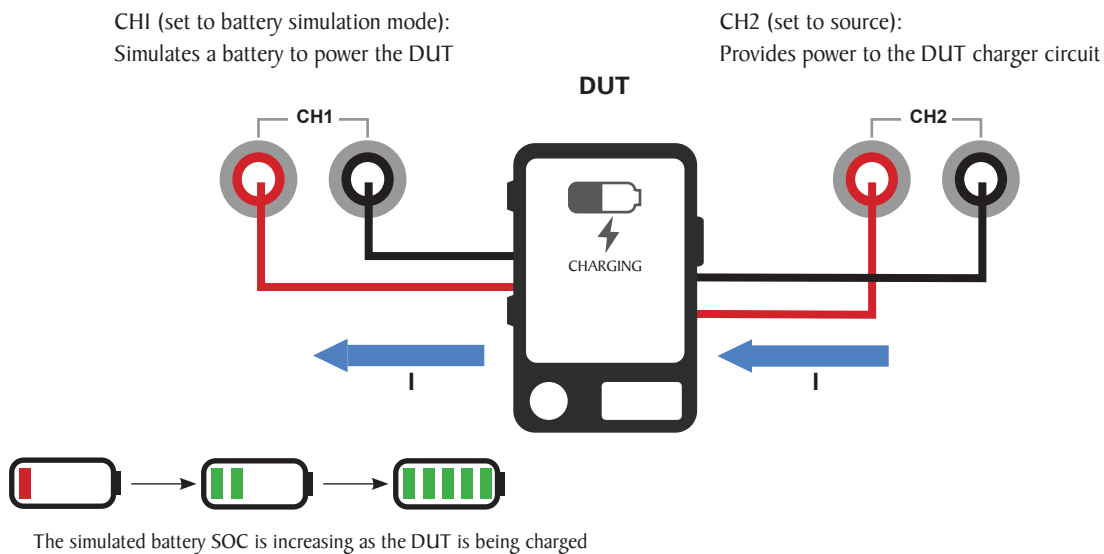

## Additional features

### Fully equipped DC power supply

Using the Source function, the BCS Series operates as a precision single-channel or dual-channel DC power supply with low noise characteristics and adjustable 0  $\Omega$  to 1  $\Omega$  output impedance. Display and monitor up to 12 parameters simultaneously including current at up to 100 nA resolution and secondary voltage measurements using the rear panel DVM.

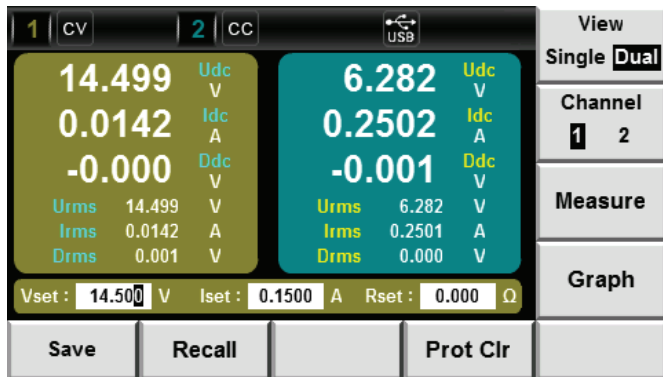

BCS640I dual channel view

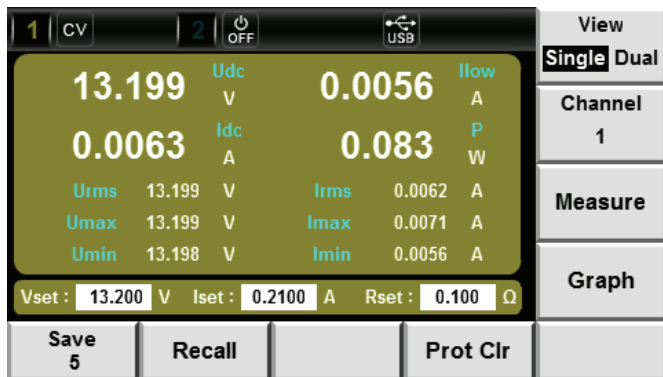

BCS640I single channel view

Other measurement parameters include min/max voltage and current, Vrms/Irms, and power. The source function also enables quick output of negative voltages down to -15 V using the BCS640I or to -30 V with the BCS6402.

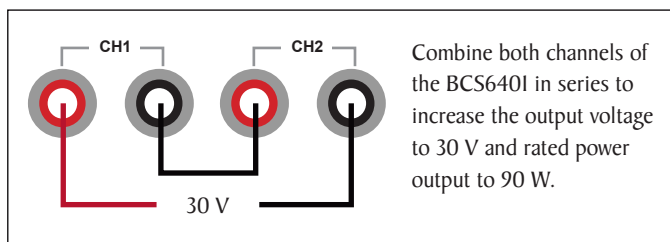

### List programming

Set up and execute complex test sequences from the front panel with programmable voltage, current, output resistance, and dwell time.

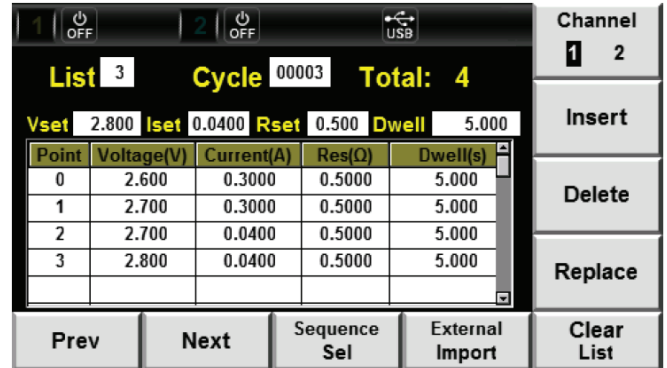

- Save up to 20 user-defined list mode programs to internal memory with up to 30 steps each
- Set a list program to repeat up to 65,535 times
- Run multiple user-defined list programs in sequence

### Graph display mode

Visually monitor voltage, current, and power measurements with the graph display mode. Oscilloscope-like triggering capabilities include configurable trigger slope, level, and delays.

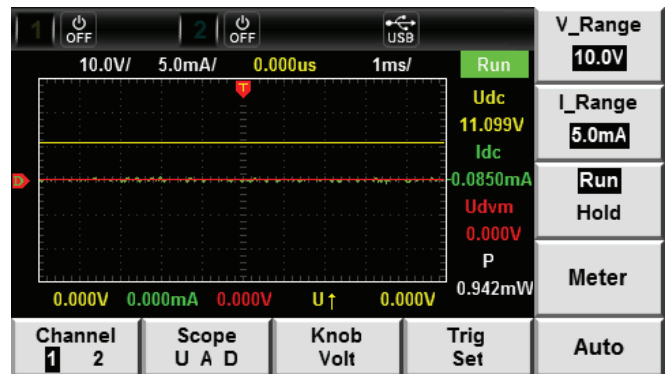

### Data logging

Voltage and current measurements stored in the buffer can be exported to a USB flash drive in .txt format.

- Configurable buffer size up to 1,024 measurements
- Buffer statistics including min, max, mean

**Front panel**

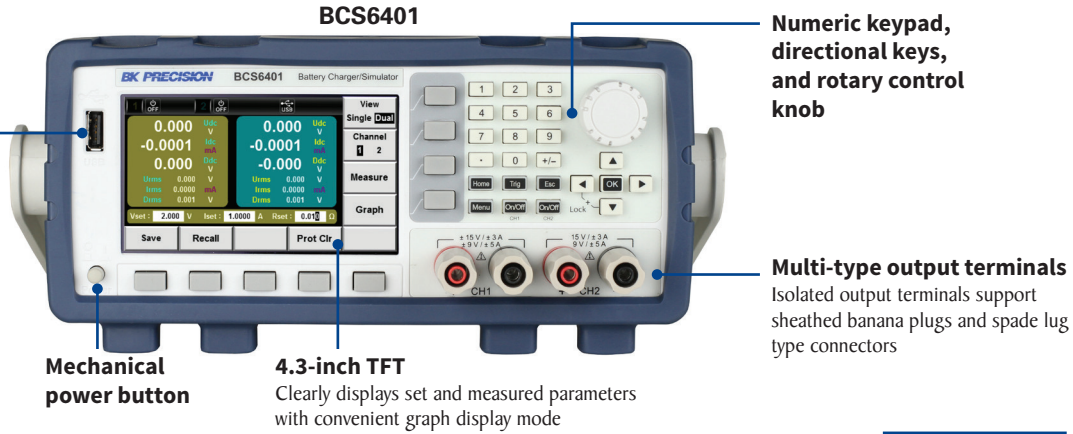

**Mechanical power button**

**4.3-inch TFT**  
Clearly displays set and measured parameters with convenient graph display mode

**Numeric keypad, directional keys, and rotary control knob**

**Multi-type output terminals**  
Isolated output terminals support sheathed banana plugs and spade lug type connectors

**USB host**  
Save/Recall instrument settings, save screenshots and list mode programs, import battery simulation profiles

**Mechanical power button**



**Numeric keypad, directional keys, and rotary control knob**

**Multi-type output terminals**  
Isolated output terminals support sheathed banana plugs and spade lug type connectors

**BCS6402**

**Rear panel**

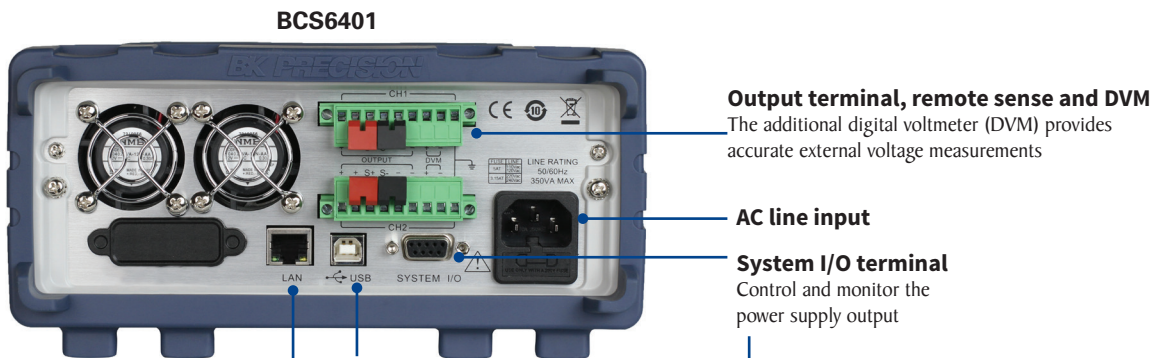

**Output terminal, remote sense and DVM**  
The additional digital voltmeter (DVM) provides accurate external voltage measurements

**AC line input**

**System I/O terminal**  
Control and monitor the power supply output

**USB interface**  
USB (USBTMC-compliant)

**LAN interface**

**Output terminal, remote sense and DVM**  
The additional digital voltmeter (DVM) provides accurate external voltage measurements

**AC line input**

**BCS6402**

## Specifications

Note: All specifications apply to the unit after a temperature stabilization time of 15 minutes over an ambient temperature range of 23 °C ± 5 °C. Specifications are valid for single unit operation only.

Model	BCS6401		BCS6402
Channels	2		1
Voltage	High	± 15 V	± 30 V
	Low	± 9 V	
Max Source / Sink Current	High	3 A	
	Low	5 A	
Power	45 W per channel, up to 90 W combined		150 W
Variable Output Impedance	0 to 1 Ω		
<b>Load Regulation ± (% output + offset)</b>			
Voltage	≤ 0.01% + 2 mV		
Current	≤ 0.05% + 1 mA		
<b>Line Regulation ± (% output + offset)</b>			
Voltage	≤ 0.02% + 2 mV		
Current	≤ 0.05% + 1 mA		
<b>Ripple and Noise (20 Hz to 20 MHz)</b>			
Normal Mode Voltage p-p	≤ 3 mV		≤ 4 mV
Normal Mode Voltage rms	≤ 1 mV		
Normal Mode Current rms	≤ 1 mA		
<b>Programming Resolution</b>			
Voltage	1 mV		
Current	0.1 mA		
Variable Output Impedance	1 mΩ		
<b>Readback Resolution</b>			
Voltage	1 mV		
Current	5 A Range	0.1 mA	
	5 mA Range	100 nA	
<b>Programming Accuracy ± (% output + offset)</b>			
Voltage	≤ 0.02% + 3 mV		
Current	≤ 0.05% + 2 mA		≤ 0.05% + 3 mA
Variable Output Impedance	≤ 0.1% + 3 mΩ		
<b>Readback Accuracy ± (% output + offset)</b>			
Voltage	≤ 0.02% + 2 mV		≤ 0.02% + 3 mV
Current	5 A Range	≤ 0.05% + 0.2 mA	
	5 mA Range <sup>(1)</sup>	≤ 0.05% + 2 μA	
<b>Temperature Coefficient ± (% output + offset) / °C</b>			
Voltage	0.005% + 0.2 mV		0.005% + 0.4 mV
Current	0.005% + 0.2 mA		0.01% + 0.2 mA
Resistance	0.02% + 0.5 mΩ		

## Specifications (cont.)

Model		BCS6401		BCS6402		
<b>Output Response Time <sup>(2)</sup></b>						
Rise Time	Voltage	Full load	≤ 500 μs		≤ 150 μs	
		No load	≤ 500 μs		≤ 150 μs	
	Current	Full load	Fast mode	≤ 150 μs	Fast mode	≤ 150 μs
			Normal mode	≤ 10 ms	Normal mode	≤ 10 ms
Fall Time	Voltage	Full Load <sup>(3)</sup>	≤ 150 μs		≤ 50 μs	
		No load	≤ 1 ms		≤ 150 μs <sup>(4)</sup>	
<b>Transient Response <sup>(5)</sup></b>						
Time		≤ 50 μs		≤ 30 μs		
<b>DVM</b>						
Measurement Range		-20 V to +20 V		-30 V to +30 V		
Resolution		1 mV				
Accuracy		0.02% + 3 mV				
<b>General</b>						
Remote Sense Compensation		1 V				
Command Response Time <sup>(6)</sup>		5 ms				
Power Factor		0.7 max.				
I/O Interfaces		USB (USBTMC-compliant) and LAN				
AC Line Input		110/220 VAC ± 10%, 47 Hz to 63 Hz				
Isolation (output to ground)		100 VDC max.				
Output Impedance (output off, typical)	Output-off state Normal	150 kΩ		200 kΩ		
	Output-off state Relay off	≥ 1 GΩ <sup>(7)</sup>		≥ 1 GΩ		
Protection Functions		OVP/OCP/OTP/Reverse voltage protection		OVP/OCP/OTP		
Maximum Rated Input Power		500 VA				
Temperature Ratings	Operation	32 °F to 104 °F (0 °C to 40 °C)				
	Storage	14 °F to 158 °F (-10 °C to 70 °C)				
Dimensions (W x H x D)		8.9" x 3.5" x 18.75" (226 x 88.2 x 476.26 mm)				
Weight		19.85 lbs (9 kg)		17.64 lbs (8 kg)		
Warranty		3 Years				
Standard Accessories		Power cord & certificate of calibration				
Optional Accessories		Rack mount kit (RK2UIS)				

Regulatory Compliance	
Safety	Low Voltage Directive (LVD) 2014/35/EU, EN61010-1:2010
Electromagnetic Compatibility	EMC Directive 2014/30/EU, EN61326-1:2013

- (1) The current readback accuracy of the 5 mA range is measured in constant voltage mode.  
(2) From 10% to 90% or from 90% to 10% of total power excursion. Using positive output polarity.  
(3) Fall time at full load when output is disabled.  
(4) The set voltage will change to 0 V when the power supply output is 30 V.  
(5) Time for output voltage to recover within 50 mV for a load change 50-100% of full load. Output speed set to Fast.  
(6) Typical time required for output to begin to change following receipt of command data.  
(7) Relay off function only supported for CHI.



## About B&K Precision

For more than 70 years, B&K Precision has provided reliable and value-priced test and measurement instruments worldwide.

Our headquarters in Yorba Linda, California houses our administrative and executive functions as well as sales and marketing, design, service, and repair. Our European customers are most familiar with B&K through our French subsidiary, Sefram. Engineers in Asia know us through our B&K Precision Taiwan operation. The independent service center in Singapore services customers in Singapore, Malaysia, Vietnam, and Indonesia.



● B&K Precision group member ● Independent service center ● Service center location

### Quality Management System

B&K Precision Corporation is an ISO9001 registered company employing traceable quality management practices for all processes including product development, service, and calibration.

ISO9001:2015

Certification body NSF-ISR  
Certificate number 6Z241-IS8



### Video Library

View product overviews, demonstrations, and application videos in English, Spanish and Portuguese.

<http://www.youtube.com/user/BKPrecisionVideos>

### Product Applications

Browse all of our supported product and mobile applications.

<http://bkprecision.com/product-applications>

**Thurlby Thandar Instrument Distribution**  
Glebe Road, Huntingdon, PE29 7DR, UK  
**+44 (0)1480 412 451**  
**sales@ttid.co.uk**  
**www.ttid.co.uk**

