

DrDAQ[®]

Versatile data acquisition

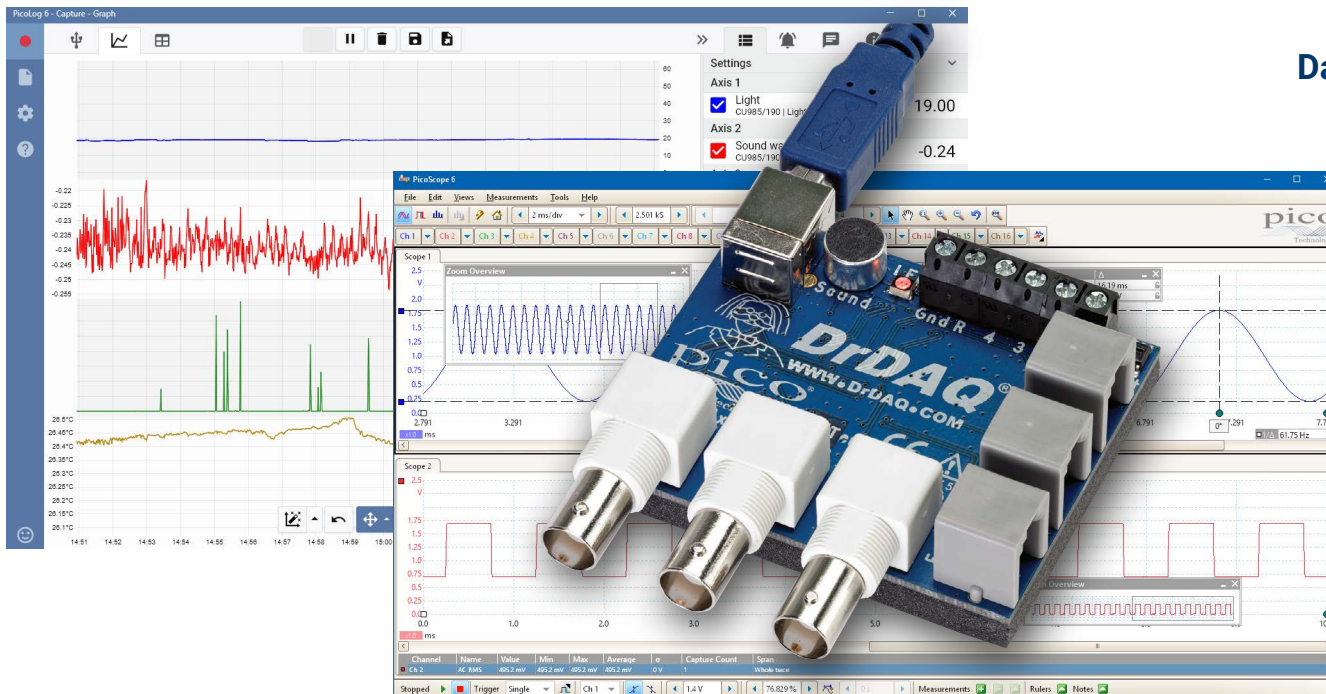

Data logger, oscilloscope, signal generator and more!

Use the built-in sensors for light, sound, and temperature

Measure pH using standard electrodes

Add external sensors and digital devices

Capture data from up to 20 DrDAQs on one PC

USB connected and powered

Free to download PicoLog 6 and PicoScope 6 software

Free software development kit

Example programs available to download

Free technical support

Free software updates

Compatible with Windows, macOS and Linux

Sensors and indicators

You can start using your DrDAQ Data Logger straight out of the box; it features built-in sensors for light, sound and temperature, and an RGB LED that you can program to show any one of 16.7 million colours. External sensor sockets also allow you to extend the functionality of your DrDAQ. With external sensors your DrDAQ can measure humidity, oxygen levels, external temperatures and much more. Pico Technology provide you with everything you need to know to connect, use, and even design your own sensors.

More than just a data logger

Thanks to the versatility of your DrDAQ you can also use it as an oscilloscope and spectrum analyzer. Just download and run PicoScope software from www.picotech.com/downloads and your DrDAQ becomes a single-channel scope with a 100 kHz bandwidth, 8-bit resolution and the ability to measure voltages of up to ± 10 volts.

Digital Input/Outputs

The DrDAQ includes 4 digital input/outputs. As inputs these give you even more monitoring options, and when used as outputs they enable you to use your DrDAQ to control external devices. Two of the digital I/Os include a pulse-counting function when used as inputs, and a pulse-width modulation (PWM) output capability.

But that's not all. Your DrDAQ also includes a signal generator which can be used as both a standard function generator and an arbitrary waveform generator (AWG). The AWG function enables you to create your own waveforms.

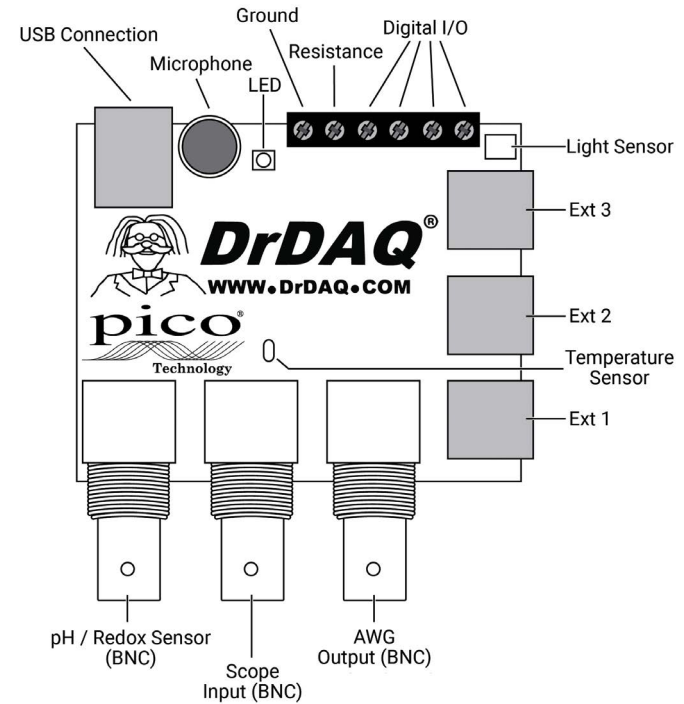

Hobbyist, student or professional: DrDAQ is all you need

The DrDAQ Data Logger has something for everyone: whether you're a teacher looking for a fun way to perform data logging experiments in the classroom, a student wanting an inexpensive introduction to data logging and oscilloscopes, a programmer who wants to use C++ to monitor and control the inputs and outputs of real-world devices, a hobbyist who wants to monitor and control their environment, or a professional wanting to measure pH under laboratory conditions – DrDAQ has everything you need.

HOBBYIST

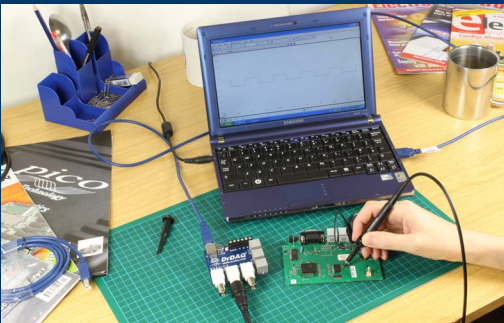

PROFESSIONAL

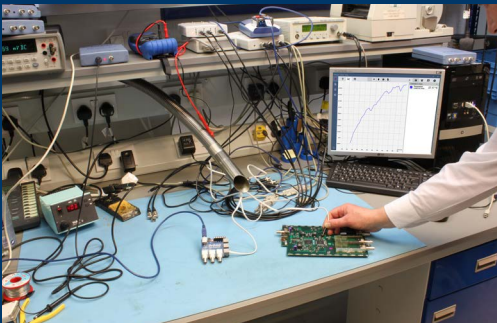

STUDENT



Data logging and oscilloscope software

A PC-based data logger is only as good as its software – that’s why the DrDAQ comes with a complete software package that enables you to use your DrDAQ not only as a data logger but also as an oscilloscope and arbitrary waveform generator. Pico Technology’s PC-based programs are easy and intuitive to use and offer superior viewing quality, making them ideal for education and training. Data can easily be saved, printed, emailed, and exported to spreadsheets and databases.

Both PicoLog and PicoScope benefit from free upgrades, technical support, and international language versions, and are compatible with Windows, macOS and Linux.

PicoLog data logging software

PicoLog is a complete data acquisition software package for the Pico Technology DrDAQ data loggers. It provides a visual, easy-to-use interface for users to quickly set up simple or complex acquisitions and record, view and analyze data.

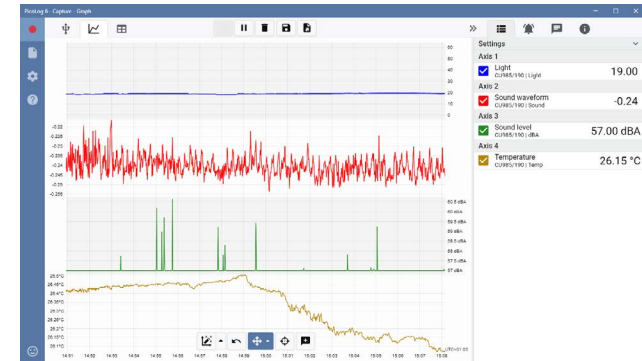

PicoScope oscilloscope software

PicoScope is your complete test and measurement lab in a single application. Using the PicoScope software you can use your DrDAQ Data Logger as an oscilloscope or spectrum analyzer, and control the integrated signal generator, RGB LED, and digital outputs.

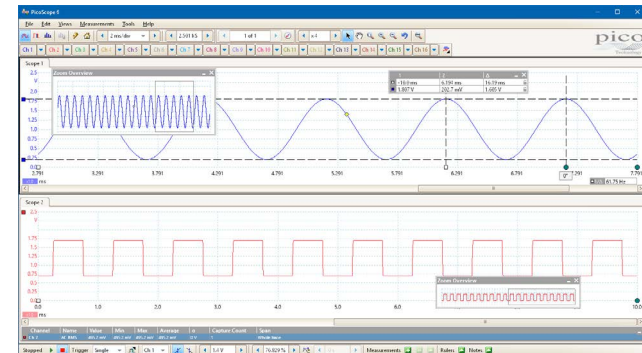

PicoSDK®

Pico’s software development kit, PicoSDK, is available free of charge and allows you to write your own software and interface to third-party software packages.

Pico also maintains repositories of example code on GitHub (github.com/picotech), showing how to use PicoSDK with software packages such as Microsoft Excel, National Instruments LabVIEW and MathWorks MATLAB, or with programming languages including C, C++, C# and Visual Basic .NET.

PicoSDK and the *DrDAQ Programmer’s Guide* are available to download from www.picotech.com/downloads.

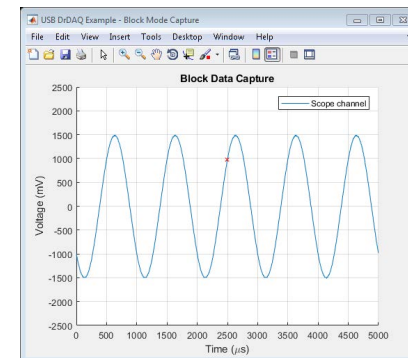

PicoLog software

PicoLog is a complete data acquisition software package for the DrDAQ data logger, and is fully compatible with Windows, macOS and Linux. With its clear and user-friendly layout, ideal for use with a mouse or a touchscreen, PicoLog allows you to set up the logger and start recording with just a few clicks of the mouse, whatever your level of data logging experience. Set up simple or advanced acquisitions quickly, and record, view and analyze your data with ease.

Device settings, Graph and Table
Easily set up and adjust acquisition and math channels on one or more data loggers and check their status at a glance. You can also select **Graph** view to see live data trend lines and **Table** view to see data tabulate in real-time.

Capture controls
Separate **Record**, **Pause** and **Reset** buttons make it harder to press any of them by mistake.

Save and Export options
Copy your graph to the clipboard, save it as a PDF, export the raw data to a CSV file, or save the data and configuration as a robust .picolog database file.

Alarms
Set up alarms to alert you to a range of events. **Alarms** can take the form of sounds, visual notifications, graph annotations and more.

Notes & annotations
Add notes about the dataset as a whole or annotations about particular points on the graph.

Graph view
Display your data in real time, as it is collected, on up to four independent Y axes simultaneously: set them up by dragging and dropping the entries in the **Channels & Axes** panel on the right.

Give instant feedback
We want to hear from you! Click here to contact Pico with your comments.

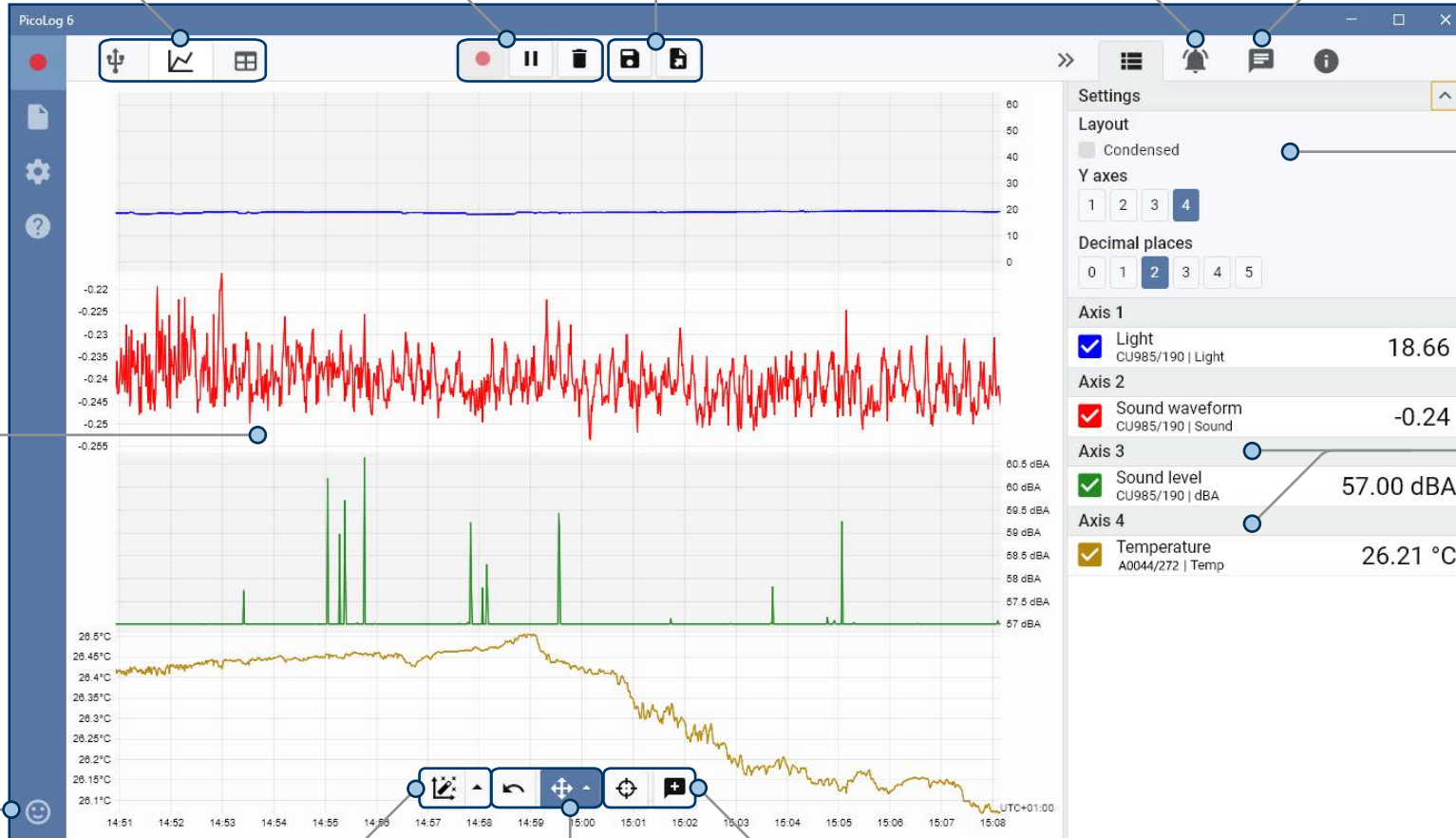

Pullout information panel
Manage your channel and axis settings, alarms, notes and capture information in this easy-to-read layout. Close the panel to make more room for the capture graph, and reopen it at any time.

Multiple devices
Log data on up to 20 devices at the same time. Here, two separate data loggers are in use: one DrDAQ and one TC-08 temperature data logger.

Data view
Display all the data collected so far (**Show all data**) or keep the graph scale the same and pan along as new samples appear (**Follow new data**).

Pan and zoom controls
Zoom in, zoom out, zoom to a selection or pan through the data with these tools. If you make a mistake, just click **Undo zoom**.

Cursors and annotations
Use **Cursor** to highlight the data value and time at any point on the graph, then click **Add annotation** to mark that point with a text note.

PicoScope software

The display can be as simple or as advanced as you need. Begin with a single view of one channel, and then expand the display to include any number of live channels, math channels and reference waveforms.

Auto setup button: Configures the collection time and voltage range for clear display of signals.

Channel options: Filtering, offset, resolution enhancement, custom probes and more.

Movable axes: The vertical axes can be dragged up and down. This feature is particularly useful when one waveform is obscuring another. There's also an **Auto Arrange Axes** command.

Zoom overview: Click and drag for quick navigation in zoomed views.

Trigger toolbar: Quick access to main controls.

Tools: Including serial decoding, reference channels, macro recorder, alarms, mask limit testing and math channels.

Waveform replay tools: PicoScope automatically records up to 10000 of the most recent waveforms. You can quickly scan through to look for intermittent events, or use the **Buffer Navigator** to search visually.

Zoom and pan tools: PicoScope allows a zoom factor of several million.

Signal generator: Generates standard signals or arbitrary waveforms. Includes frequency sweep mode.

RGB LED: Allows you to manually control the built-in RGB LED to show any one of 16.7 million colors.

Digital outputs: Allows you to set the characteristics of the four digital outputs on the screw terminal block of your DrDAQ.

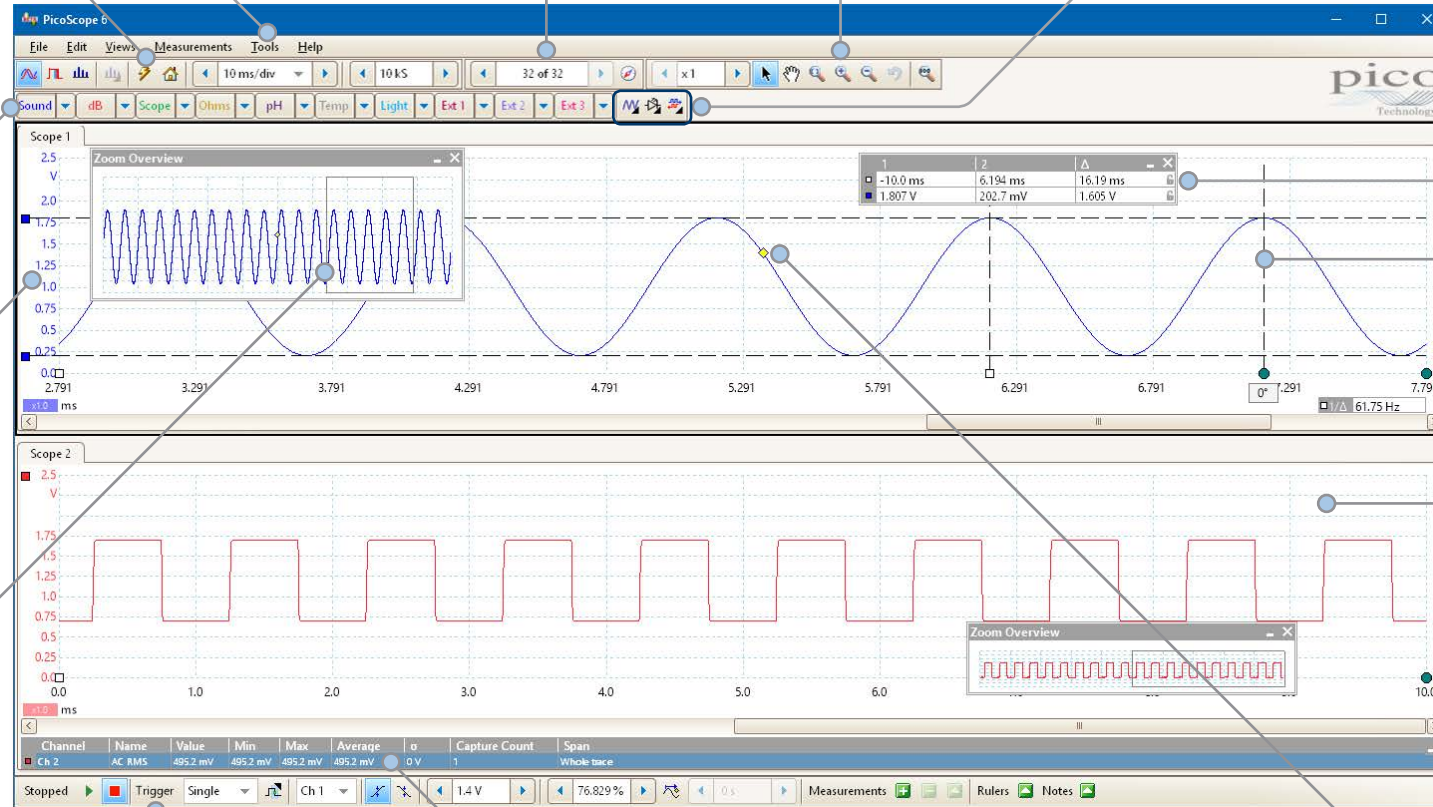

Ruler legend: Absolute and differential ruler measurements are listed here.

Rulers: Each axis has two rulers that can be dragged across the screen to make quick measurements of amplitude, time and frequency.

Views: PicoScope is carefully designed to make the best use of the display area. You can add new scope, spectrum and XY views with automatic or custom layouts.

Automatic measurements: Display calculated measurements for troubleshooting and analysis. You can add as many measurements as you need on each view. Each measurement includes statistical parameters showing its variability.

Trigger marker: Drag the yellow diamond to adjust trigger level and pre-trigger time.

Math channels

Sometimes you need to use data from one or more measurement channels to graph and record a calculated parameter. You can use the PicoLog equation editor to set up simple math channels such as $A-B$ or more complex functions such as \log , \sqrt{x} , abs , round , min , max , mean and median .

PicoLog treats math channels like any other channel, so you can still set alarms and annotate them.

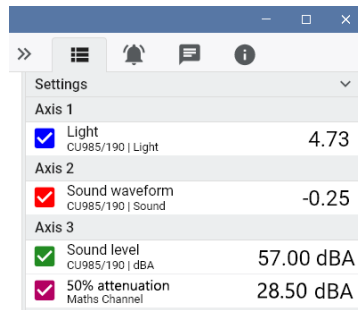

| Axis | Channel | Value |
|--------|-------------------------------------|-----------|
| Axis 1 | Light CU985/190 Light | 4.73 |
| Axis 2 | Sound waveform CU985/190 Sound | -0.25 |
| Axis 3 | Sound level CU985/190 dBA | 57.00 dBA |
| | 50% attenuation Maths Channel | 28.50 dBA |

Alarms

In PicoLog, you can set up alarms to alert you to various events. These can be as simple or as complex as you like: alarms can trigger on a signal threshold or disconnection of the data logger, or you can set up a logic expression of your own. Alarms can play sounds, display visual alerts, run applications or mark when the event occurred on the graph.

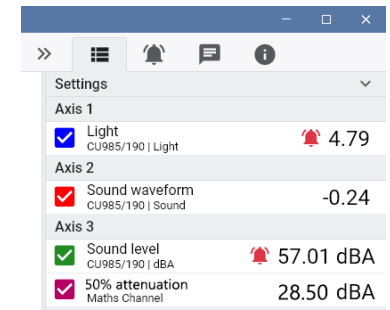

| Axis | Channel | Value |
|--------|-------------------------------------|-----------|
| Axis 1 | Light CU985/190 Light | 4.79 |
| Axis 2 | Sound waveform CU985/190 Sound | -0.24 |
| Axis 3 | Sound level CU985/190 dBA | 57.01 dBA |
| | 50% attenuation Maths Channel | 28.50 dBA |

Intuitive logger and channel setup

The **Devices** view lets you set up a multichannel acquisition system in a simple way, with the option to use multiple different Pico data loggers simultaneously. PicoLog shows you an image of each connected device, so you can quickly and easily enable or disable channels and set up their properties.

On the right, you can see the device setup for the acquisition of data from a DrDAQ and one TC-08 temperature data logger.



The screenshot shows the PicoLog 6 - Capture - Devices interface. On the left, there are icons for DrDAQ CU985/190 and TC-08 A0044/272. The main area displays a grid of device icons. On the right, the Settings window is open, showing the following configuration:

| Axis | Channel | Value |
|--------|-------------------------------------|-----------|
| Axis 1 | Light CU985/190 Light | 6.10 |
| Axis 2 | Sound waveform CU985/190 Sound | -0.25 |
| Axis 3 | Sound level CU985/190 dBA | 57.00 dBA |
| Axis 4 | Temperature CU985/190 Temp | 25.26 °C |
| | Channel 1 A0044/272 1 Type K | 22.15 °C |
| | Channel 4 A0044/272 4 Type K | 22.14 °C |

Robust file format

At the heart of PicoLog is the file system, which stores live capture data directly to a robust database, rather than to a single file that is vulnerable to corruption and data loss. If the computer is shut down and rebooted, PicoLog will only lose the data during the outage – saving resumes when you restart the software.

This file system also means that the size of the dataset you can capture you is virtually unlimited – the only restriction is the size of your computer's hard disk!

The .picolog file format is compatible across all operating systems, and there is no need to set up a file to save to before the capture is complete. You can also save mid-capture if you wish to share the data collected so far. Since anyone can download and install PicoLog for free, you can easily share saved data with co-workers, customers and suppliers for offline post-analysis.

Data can be exported as CSV. In addition, you can export a PDF containing a graph, channel configuration, capture notes, annotation notes and alarm trigger history.

PicoSDK®

Pico's software development kit, PicoSDK, is available free of charge and allows you to write your own software and interface to third-party software packages.

Pico also maintains repositories of example code on GitHub (github.com/picotech), showing how to use PicoSDK with software packages such as Microsoft Excel, National Instruments LabVIEW and MathWorks MATLAB, or with programming languages including C, C++, C# and Visual Basic .NET.

PicoSDK and the *DrDAQ Programmer's Guide* are available to download from www.picotech.com/downloads.



Try the PicoLog software today!

PicoLog's built-in demo mode allows you to try out the full functionality of the software with a choice of virtual devices and simulated live data. You also can use PicoLog to view previously saved data, even with no device connected. Visit www.picotech.com/downloads and select **PicoLog Data Loggers** to get your copy.

Specifications

| | |
|---|--|
| Number of channels | 14 |
| Maximum sampling rates: | |
| Block mode (PicoScope and PicoSDK) | 1 MS/s ^[1] |
| USB streaming (PicoScope) | 1 kS/s ^[2] |
| USB streaming (PicoSDK) | 100 kS/s ^[3] |
| PicoLog maximum USB streaming rate | 1 kS/s |
| Memory depth (block mode) | 16 320 samples at 1 MS/s, 1 000 000 samples at slower rates ^[3] |
| Memory depth (USB streaming) | |
| PicoScope | 1 MS |
| Using PicoSDK | Unlimited |
| ^[1] Single channel only. ^[2] Per active channel. ^[3] Shared between active channels. | |
| Oscilloscope/spectrum analyzer channel | |
| Bandwidth | 100 kHz |
| Resolution | 8 bits |
| Input impedance | 1 M Ω |
| Input type | Single-ended, BNC(f) connector |
| Input coupling | DC |
| Input ranges (full scale) | ± 1.25 V, ± 2.5 V, ± 5 V, ± 10 V |
| DC accuracy | $\pm 3\%$ |
| Timebases | 10 μ s/div to 5000 s/div |
| Function generator/arbitrary waveform generator (AWG) output | |
| Channels | 1 |
| Connector | BNC |
| Standard waveforms | Sine, square, triangle, ramp (up/down), DC level |
| Function generator frequency range | DC to 20 kHz |
| Signal amplitude | 0 to 1.5 V in 2 mV steps |
| Signal offset | ± 1.5 V in 2 mV steps |
| Accuracy | ± 10 mV |
| AWG frequency range | DC to 100 kHz |
| AWG buffer size | 4096 samples |
| AWG update rate | 2 MS/s (maximum) |
| AWG resolution | 10 bits |

| Built-in sensors/outputs | | | | |
|--------------------------|---|---|----------------|-------------------------------|
| Channel | | Range | Resolution | Accuracy |
| Sound waveform | | ±100 | ±0.2 | not calibrated |
| Sound level | | 55 to 100 dB | 1 dB | 5 dB |
| Temperature | | -10 to +70 °C | 0.1 °C @ 25 °C | 2 °C @ 25 °C |
| Light | | 0 to 100 | 0.1 | not calibrated |
| RGB LED | | 16.7 million colours | 8 bit x 3 | not applicable |
| Analog inputs | | | | |
| Type | Connector | Range | Resolution | Accuracy |
| pH | BNC | 0 to 14 pH | 0.02 pH | Depends on sensor calibration |
| Redox/ORP | BNC (shared with pH) | ±2000 mV @ 1 TΩ | 1.2 mV | Depends on sensor calibration |
| Resistance | Screw terminal | 0 to 1 MΩ | 250 Ω @ 10 k | 5% |
| External sensors | 3 x FCC68 4/4 | Measure 0 to 2.5 V (Also supply power to external sensors and identify sensor type via ID resistor.) | 1 mV | 1% |
| Configurable digital IO | | | | |
| Channels | 4 | | | |
| Connector type | Screw terminals | | | |
| Input characteristics | 0 to 5 V (Low:0 to 0.8 V, High: 2 to 5.5 V) TTL compatible | | | |
| Output characteristics | 3.3 V, 2.2 kΩ output impedance | | | |
| PWM output | Available on 2 Digital IO channels | | | |
| Period | <65535 μs | | | |
| Pulse width | ≥1 μs | | | |
| Pulse counting | Available on 2 Digital IO channels | | | |
| Range | Up to 65535 counts @ 500 kHz | | | |

| Software | |
|--|--|
| PicoLog, PicoScope and PicoSDK | Available from www.picotech.com/downloads |
| PicoSDK example code | Available from Pico's GitHub organization page, github.com/picotech |
| PicoLog user interface languages | English, French, Italian, German, Spanish, Korean, Japanese, Chinese (simplified), Russian |
| PicoScope user interface languages | Chinese (simplified), Chinese (traditional), Czech, Danish, Dutch, English, Finnish, French, German, Greek, Hungarian, Italian, Japanese, Korean, Norwegian, Polish, Portuguese, Romanian, Russian, Spanish, Swedish, Turkish |
| PC requirements | |
| PicoLog | Microsoft Windows 7, 8 or 10, 32-bit and 64-bit versions, macOS 10.9 (Mavericks) or later, 64-bit only, Linux*, 64-bit only Hardware requirements as operating system. * PicoLog for Linux is distributed as an Appliance, so you can install it without superuser permissions: see appimage.org for further information. The software has been tested on OpenSUSE and Ubuntu. |
| PicoScope ^[4] | PicoScope Stable: Windows 7, 8 or 10 (32 or 64-bit). PicoScope Beta: macOS 10.9 (Mavericks) or later, 64-bit only, Linux (OpenSUSE and Ubuntu). Hardware requirements as operating system. |
| PicoSDK ^[4] | Only available for Windows. Drivers also available for 64-bit Linux and macOS. |
| PC interface | USB 2.0 full speed (USB 1.1 and USB 3.1 compatible) |
| ^[4] PicoScope R6.11 and PicoSDK 10.6.11 are the last versions compatible with Microsoft Windows XP (SP3) and Vista SP2, and they are also compatible with the Windows versions above. | |
| Environmental | |
| Operating temperature | 0 to 70 °C (20 to 30 °C for stated accuracy) |
| Storage temperature | -20 to +80 °C |
| Operating humidity | 5 to 80 %RH, non-condensing |
| Storage humidity | 0 to 95 %RH, non-condensing |
| General | |
| Additional hardware (supplied) | USB 2.0 cable and user manuals |
| Input overvoltage protection | ±30 V |
| Power requirements | Powered from USB port |
| Dimensions | 77 x 70 x 23 mm (approx 3 x 2.7 x 0.9 in) (includes BNC connectors) |
| Weight | 60 g (approx 2.1 oz) |
| Compliance | European EMC and LVD standards FCC Rules Part 15 Class A RoHS compliant |
| Warranty | 5 years |

External sensors and probes

As well as the built-in sensors, DrDAQ has sockets for optional external sensors. When a sensor is plugged in the software detects it and will automatically scale the readings. For example, when a temperature sensor is plugged in the readings are displayed in °C, and for a humidity sensor the readings are displayed in % RH.

DD100 Temperature Sensor

A high-accuracy general purpose temperature sensor with a 2 metre lead. Suitable for air, surface, or liquid measurements.



| | |
|----------------------|-------------------------------|
| Range | -10 to +105 °C (14 to 221 °F) |
| Resolution (at 25°C) | 0.1 °C (0.18 °F) |
| Accuracy (at 25°C) | 0.3 °C (0.54 °F) |

DD011 DrDAQ pH sensor

A robust epoxy-bodied pH electrode ideal for educational use. The pH sensor consists of a standard electrode capable of measuring the full 0 to 14 pH range, and comes complete with a small bottle of storage solution to help prevent it from drying out.



| | |
|-----------------------|---------------------------|
| Size | 12 x 120 mm |
| Operating temperature | 0 to 60 °C (32 to 140 °F) |
| Resolution | 0.02 pH |

PP163 DrDAQ humidity sensor

A sensor which measures humidity using a 'non-condensing' technique. It has a short response time and plugs into the external sensor connections of the DrDAQ.



| | |
|-----------------------|---------------------------------------|
| Size | 72 x 45 x 28 mm |
| Operating range | 20 to 90 %RH |
| Overall accuracy | Reading ± 10% |
| Operating temperature | 0 to 60 °C (32 to +140 °F) |
| Resolution | 0.2 %RH |
| Minimum response time | 60 seconds with vigorous air movement |
| Maximum response time | 60 minutes in still air |

PP214 Oxygen Sensor

A sensor which can be used to measure the percentage of oxygen in a gas.



| | |
|-----------------------|--|
| Sensor type | Galvanic Cell (lead-oxygen with weak acid electrolyte) |
| Input range | 0 to 100% oxygen |
| Accuracy (calibrated) | ±3.0% over operating conditions range |
| Response times | < 15 seconds for 90% response < 25 seconds for 97% response |
| Humidity | 0 to 95% Non-condensing |
| Operating temperature | 5 to 40 °C (41 to 104 °F) |
| Storage temperature | -15 to 50 °C (5 to 122 °F) |

TA375 Passive oscilloscope probe

Our ergonomically designed passive oscilloscope probe with switchable 1:1 or 10:1 attenuation is suitable for use with any oscilloscope with a 1 MΩ input and 10 to 35 pF capacitance range as well as the PicoScope range of USB Oscilloscopes. Passive probes don't require a power supply or batteries so are lightweight and easily portable.



| | | |
|----------------------|---------------------------|---------------|
| | x1 | x10 |
| Attenuation | 1:1 | 10:1 |
| Bandwidth | DC to 10 MHz | DC to 100 MHz |
| Rise time | 35 ns | 3.5 ns |
| Input resistance | 1 MΩ | 10 MΩ ± 2% |
| Input capacitance | 57 pF + C _S ** | 15 pF |
| Cable length | 1.2 m nominal | |
| ** scope capacitance | | |

PP066 DrDAQ reed switch

The reed switch sensor can be used to detect the presence of a magnetic field such as from a bar magnet or an electromagnet. Alternatively, a simple external switch can be wired to the internal screw terminals. It has a fast response time of 2 ms so can be used as an alternative to a light gate for timing applications. Other uses include monitoring the amount of time a door is left open or a machine running.



TA137 DrDAQ redox sensor

The DrDAQ redox sensor (also known as an ORP sensor) can measure redox potential in the range of -1500 mV to $+1500$ mV. Positive readings indicate an increase in oxidation state (loss of electrons), while negative readings indicate a reduction in the oxidation state (gain of electrons).



PP216 magnetic induction kit

The Magnetic Induction Kit can be used to demonstrate electromagnetic induction, the direction of induced currents and variation of the size of induced EMF with velocity. It can also be used as a student-based investigation, either with full instructions or as an open investigation where the students research the concepts.



| | |
|---------------------|------------------------------|
| Size | 12 x 160 mm |
| Measuring range | ± 1500 mV |
| Junction | Ceramic |
| Reference cell | Ag/AgCl, KCl gel |
| Sensitive component | Dia.6 x 2.5 mm platinum ring |
| Plug | BNC with 1 meter cable |

Available kits and contents

The DrDAQ is available as a single unit or as part of a kit, as detailed below:

PP706 DrDAQ

- DrDAQ
- USB installation guide
- Cable: USB 2.0 1.8 m blue

PP707 DrDAQ Data logging kit

- DrDAQ
- pH electrode
- 2 DrDAQ 2 m temperature sensors
- DrDAQ humidity sensor
- USB installation guide
- 3 m sensor extension cable
- Scope probe x1/x10 switchable
- Cable: USB 2.0 1.8 m blue

PP716 DrDAQ pH logging kit

- DrDAQ
- pH electrode
- DrDAQ 2 m temperature sensor
- USB installation guide
- Cable: USB 2.0 1.8 m blue



Ordering information

| Order code | Product name | Description | USD* | EUR* | GBP* |
|------------|-----------------------|--|------|------|------|
| PP706 | DrDAQ | USB connected data logger, oscilloscope, signal generator and more, with built-in sensors. | 129 | 109 | 95 |
| PP716 | DrDAQ pH logger kit | Includes the standard pH electrode for measuring and data logging over the full pH range. | 199 | 169 | 139 |
| PP707 | DrDAQ data logger kit | Includes one scope probe, two temperature sensors and one humidity sensor for additional measurements. | 329 | 279 | 225 |

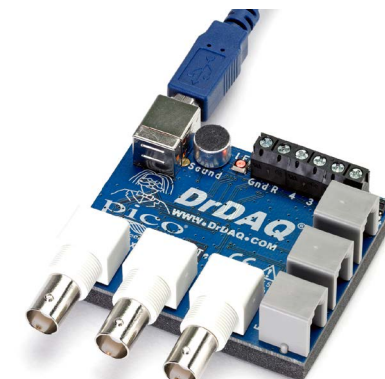

Optional accessories

| Order code | Product name | Description | USD* | EUR* | GBP* |
|------------|--|--|------|------|------|
| DD100 | DrDAQ temperature sensor | High-accuracy general-purpose thermistor temperature sensor with a two-meter lead. | 25 | 21 | 18 |
| DD011 | DrDAQ pH sensor | Epoxy-bodied standard electrode capable of measuring the full 0 to 14 pH range. | 58 | 49 | 41 |
| PP163 | DrDAQ humidity sensor | Non-condensing humidity sensor with a short response time. | 81 | 69 | 56 |
| PP214 | DrDAQ oxygen sensor | Measures the percentage of oxygen in a gas. | 159 | 139 | 119 |
| TA137 | DrDAQ redox sensor | Measure redox potential in the range of -1500 mV to +1500 mV. | 179 | 149 | 129 |
| PP066 | DrDAQ reed switch | Detect the presence of a magnetic field such as from a bar magnet or an electromagnet. | 33 | 28 | 22 |
| EL032 | DrDAQ sensor extension cable, 3 m | Replacement 3 meter (about 10 ft) sensor cable for DrDAQ sensors. | 17 | 14 | 11 |
| PP216 | Magnetic induction kit | The Kit provides a simple and effective method for students to investigate the concepts of Faraday's laws. | 58 | 49 | 21 |
| TA375 | Passive oscilloscope probe | Passive oscilloscope probe: 100 MHz bandwidth 1:1/10:1 switchable, BNC | 25 | 21 | 17 |
| DD010 | "Datalogging in Practice" by Roger Frost | This 142 page book contains a huge number of experiment ideas for teachers. | 30 | 26 | 21 |
| MI106 | USB 2.0 cable, 1.8 m** | Replacement Pico blue USB 2.0 cable, 1.8 m | 9 | 7 | 6 |
| TA268 | USB 2.0 cable, 0.5 m** | Pico blue USB 2.0 cable, 0.5 m | 9 | 7 | 6 |

* Prices correct at the time of publication. Sales taxes not included. Please check www.picotech.com for the latest prices before ordering.

** Pico blue USB cables are designed and built specifically for use with Pico Technology oscilloscopes and data loggers in order to minimize voltage drop and noise. Take care to use your DrDAQ with Pico blue USB cables only.

DrDAQ science experiments

Our website has a number of suggested scientific experiments using the DrDAQ. The example below uses the addition of a pH probe to test the pH level of a range of common drinks.

Example experiment

Dentists always warn about the dangers of drinking acidic drinks. Teenagers, they suggest, who drink large amounts suffer from tooth erosion whereby the enamel covering of the tooth is dissolved by the acid in the drink. Athletes are also at risk from drinking sports drinks.

The recommended 'safe' pH level for drinks is 5.5, and anything below this can promote tooth erosion. This experiment looks at the relative pH values of different drinks and can be used to determine whether a particular drink is 'safe' according to the above criteria. It can also be used as a good introduction to further studies into tooth decay and enamel stripping.

This experiment is suitable for ages 14+ and requires some knowledge of the pH measurement.

For further information on this experiment, please visit: picotech.com/library/experiment/ph-level-drinks-drdaq.

For the full list of experiments, please visit: picotech.com/library/experiments.

The screenshot shows the Pico Technology website page for the DrDAQ experiment. The page title is "Testing the pH level of common drinks using DrDAQ as a pH meter: results". It features a table of results and a 3D bar chart comparing expected vs recorded pH values.

| Liquid | Expected pH | Recorded pH |
|---------------|-------------|-------------|
| Milk | 8 | 6.76 |
| Lemon squash | 4.5 | 3.56 |
| Ribena | 5 | 3.19 |
| Cherry Coke | 3 | 2.17 |
| Pepsi | 3 | 2.63 |
| Original Coke | 2.5 | 2.61 |
| Black coffee | 7.5 | 5.51 |
| Black tea | 7.5 | 6.37 |
| Lemon tea | 5 | 3.73 |
| Apple juice | 3.5 | 3.49 |
| Orange juice | 4 | 3.84 |

Graph of Expected results vs Recorded results

UK global headquarters:

Pico Technology
James House
Colmworth Business Park
St. Neots
Cambridgeshire
PE19 8YP
United Kingdom

+44 (0) 1480 396 395
+44 (0) 1480 396 296
sales@picotech.com

North America regional office:

Pico Technology
320 N Glenwood Blvd
Tyler
Texas 75702
United States

+1 800 591 2796
+1 620 272 0981
sales@picotech.com

Asia-Pacific regional office:

Pico Technology
Room 2252, 22/F, Centro
568 Hengfeng Road
Zhabei District
Shanghai 200070
PR China

+86 21 2226-5152
pico.china@picotech.com

Errors and omissions excepted. *Pico Technology*, *PicoLog*, *PicoScope*, *PicoSDK* and *DrDAQ* are internationally registered trademarks of Pico Technology Ltd.

LabVIEW is a trademark of National Instruments Corporation. *Linux* is the registered trademark of Linus Torvalds, registered in the U.S. and other countries. *macOS* is a trademark of Apple Inc., registered in the U.S. and other countries. *MATLAB* is a registered trademark of The MathWorks, Inc. *Windows* and *Excel* are registered trademarks of Microsoft Corporation in the United States and other countries.

MM004.en-15. Copyright © 2004–2018 Pico Technology Ltd. All rights reserved.

Thurlby Thandar Instrument Distribution
Glebe Road, Huntingdon, PE29 7DR, UK
+44 (0)1480 412 451
sales@ttid.co.uk
www.ttid.co.uk

TTid.co.uk
THURLBY THANDAR
instrument distribution



www.picotech.com



Pico Technology



@LifeAtPico



@picotechnologyltd



Pico Technology



@picotech