



PicoScope® 5000 Series

FLEXIBLE RESOLUTION OSCILLOSCOPES

High Speed and High Resolution

FLEXIBLE HIGH-PERFORMANCE PC OSCILLOSCOPES

Flexible resolution, from 8 to 16 bits

Up to 200 MHz analog bandwidth

Up to 512 MS buffer memory

Up to 1 GS/s real-time sampling

Up to 10 GS/s equivalent-time sampling



Up to 200 MHz spectrum analyzer
Built-in function generator or AWG
USB-connected

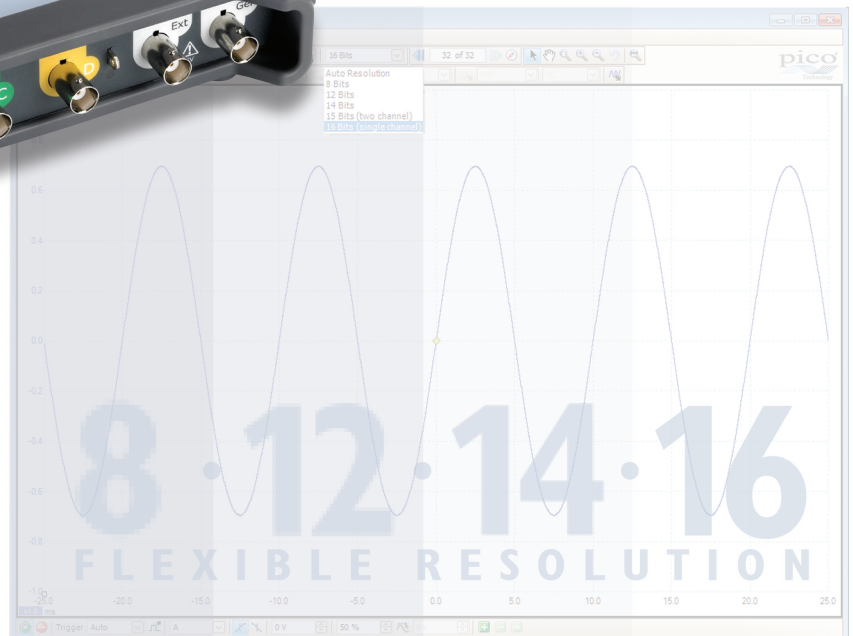

Supplied with SDK including example programs • Free technical support • Free updates
Software compatible with Windows XP, Windows Vista, Windows 7 and Windows 8

www.picotech.com

PicoScope: power, portability and versatility

Pico Technology continues to push the limits of PC oscilloscope design. For the first time in an oscilloscope, Pico Technology have used reconfigurable ADCs to offer a choice of 8-bit to 16-bit resolutions in a single product.

Flexible resolution

Most digital oscilloscopes gain their high sampling rates by interleaving multiple 8-bit ADCs. Despite careful design, the interleaving process introduces errors that always make the dynamic performance worse than the performance of the individual ADC cores.

The new PicoScope 5000 Series scopes have a significantly different architecture in which multiple high-resolution ADCs can be applied to the input channels in different time-interleaved and parallel combinations to boost either the sampling rate or the resolution.

In time-interleaved mode, the ADCs are interleaved to provide 1 GS/s at 8 bits (see left diagram below). Interleaving reduces the performance of the ADCs, but the resulting (60 dB SFDR) is still much better than oscilloscopes that interleave 8-bit ADCs. This mode can also provide 500 MS/s at 12 bits resolution.

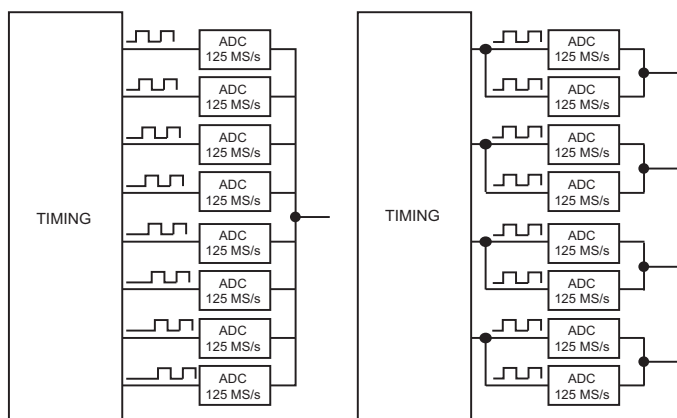

In parallel mode, multiple ADCs are sampled in phase on each channel to increase the resolution and dynamic performance (see right diagram above). Sampling in parallel with multiple ADCs and combining the output reduces noise and also both the integral and differential nonlinearity. Using parallel mode, resolution is increased to 14 bits at 125 MS/s per channel (70 dB SFDR). If only two channels are required then resolution can be increased to 15 bits, and in single-channel mode all the ADCs are combined to give a 16-bit mode at 62.5 MS/s. The software gives the choice of selecting the resolution or leaving the scope in "auto resolution" mode where the optimum resolution is used for the chosen settings.

Portability

Pico Technology oscilloscopes are small, light and portable. In 2-channel mode the 5000 Series scopes can be powered from USB only, making them ideal for the engineer on the move. The external power supply is only needed when operating more than 2 channels. The 5000 Series oscilloscopes are suitable for field use in many applications, such as design, research, test, education, service and repair.

High bandwidth, high sampling rate

Most USB-powered oscilloscopes have real-time sampling rates of only 100 or 200 MS/s, but the PicoScope 5000 Series offers up to 1 GS/s, and a maximum bandwidth of 200 MHz. Equivalent time sampling (ETS) mode can be used to further boost the sampling rate to 10 GS/s for a more detailed view of repetitive signals.

Digital triggering

Most digital oscilloscopes sold today still use an analog trigger architecture based on comparators. This can cause time and amplitude errors that

cannot always be calibrated out. The use of comparators often limits the trigger sensitivity at high bandwidths.

In 1991 we pioneered the use of fully digital triggering using the actual digitized data. This technique reduces trigger errors and allows our oscilloscopes to trigger on the smallest signals, even at the full bandwidth. Trigger levels and hysteresis can be set with high precision and resolution.

Digital triggering also reduces re-arm delay and this, combined with the segmented memory, allows the triggering and capture of events that happen in rapid sequence. At the fastest timebase you can use rapid triggering to collect 10,000 waveforms in under 20 milliseconds. Our mask limit testing function can then scan through these waveforms to highlight any failed waveforms for viewing in the waveform buffer.

Huge buffer memory

The PicoScope 5000 Series offers memory depths up to 512 million samples, more than any other oscilloscope in this price range.

Other oscilloscopes have high maximum sampling rates, but without deep memory they cannot sustain these rates on long timebases. Using its 512 MS buffer, the PicoScope 5444B can sample at 1 GS/s all the way down to 50 ms/div (500 ms total capture time).

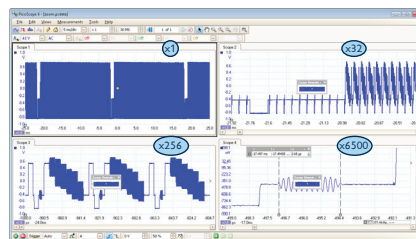

Managing all this data calls for some powerful tools. There's a set of zoom buttons, plus an overview window that lets you zoom and reposition the display by simply dragging with the mouse. Zoom factors of several million are possible.

Each captured waveform is stored in a segmented buffer so you can rewind and review up to 10,000 previous waveforms. No longer will you see a glitch on the screen only for it to vanish before you stop the scope. A mask can be applied to hide waveforms that are not of interest.

Advanced triggers

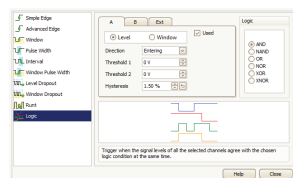

As well as the standard range of triggers found on all oscilloscopes, the PicoScope 5000 Series offers an industry-leading set of advanced triggers including pulse width, windowed and dropout triggers to help you capture the data you need.

Arbitrary waveform and function generator

All units have a built-in function generator. As well as basic controls to set level, offset and frequency, more advanced controls allow you to sweep over a range of frequencies. Combined with the spectrum peak hold option this makes a powerful tool for testing amplifier and filter responses.

The PicoScope 5000 Series B models include an arbitrary waveform

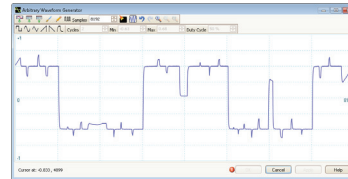

generator. Waveforms can be created or edited using the built-in AWG editor, imported from oscilloscope traces, or loaded from a spreadsheet.

High signal integrity

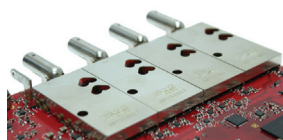

Most oscilloscopes are built down to a price; ours are built up to a specification.

Careful front-end design and shielding reduces noise, crosstalk and harmonic distortion. Years of oscilloscope experience leads to improved pulse response and bandwidth flatness.

High-end features as standard

Buying a scope from some companies is a bit like buying a car. By the time you have added all the optional extras you need, the price has gone up considerably. With the PicoScope 5000 Series, high-end features such as mask limit testing, serial decoding, advanced triggering, measurements, math, XY mode, digital filtering and segmented memory are all included in the price.

To protect your investment, both the PC software and firmware inside the unit can be updated. We have a long history of providing new features for free as software downloads. Other companies make vague promises about future enhancements but we deliver on our promises year after year. Users of our products reward us by becoming lifelong customers, frequently recommending us to their colleagues.

The design of the PicoScope software ensures that maximum display area is available for waveform viewing. Even with a laptop you have a much bigger viewing area and higher resolution than a typical benchtop scope.

Persistence display modes

See old and new data superimposed, with new data in a brighter color or shade. This makes it easy to see glitches and dropouts and to estimate their relative frequency. Choose between analog persistence and digital color, or create a custom display mode.

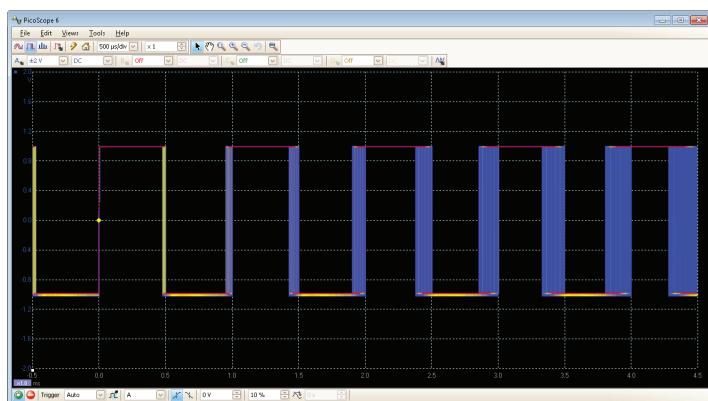

Serial decoding

The PicoScope 5000 Series, with its deep memory, is ideal for serial decoding as it can capture thousands of frames of uninterrupted data. Protocols currently included are I²C, SPI, RS232/UART, CAN, LIN and FlexRay. Expect this list to grow with free software updates.

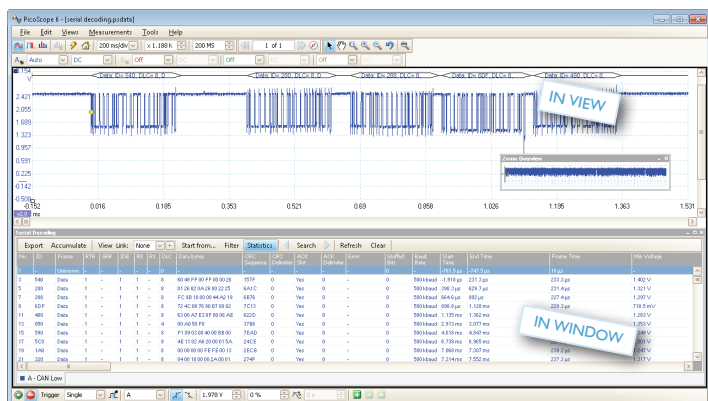

High-speed data acquisition/digitizer

The drivers and software development kit supplied allow you to write your own software or interface to popular third-party software packages such as LabVIEW.

If the scope's ultra-deep memory isn't enough, the driver supports data streaming, a mode that captures gap-free continuous data through the

USB port directly to the PC's RAM or hard disk at a rate of over 10 MS/s (maximum speed is PC-dependent).

Mask limit testing

This feature is specially designed for production and debugging environments. Capture a signal from a known working system, and PicoScope will draw a mask around it with your specified tolerance.

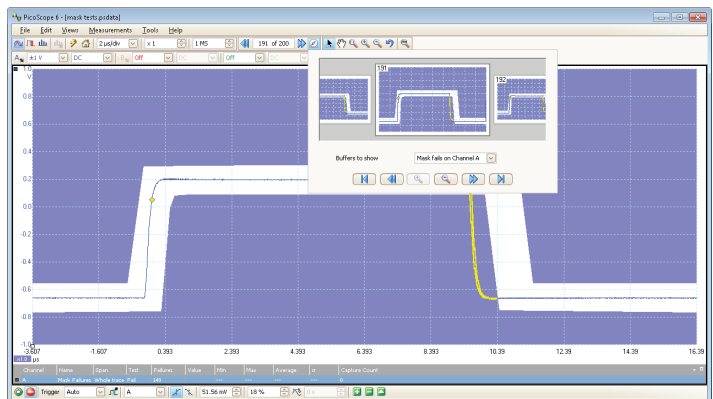

Connect the system under test, and PicoScope will highlight any parts of the waveform that fall outside the mask area. The highlighted details persist on the display, allowing the scope to catch intermittent glitches while you work on something else. The measurements window counts the number of failures, and can display other measurements and statistics at the same time. You can import and export masks as files.

Custom probe settings

The custom probes feature allows you to correct for gain, attenuation, offsets and nonlinearities in special probes, or to convert to different units of measurement (such as current, power or temperature). You can save definitions to disk for later use.

Spectrum analyzer

With a click of a button, you can display a spectrum plot of the selected channels with a maximum frequency up to 200 MHz. A full range of settings gives you control over the number of spectrum bands, window types and display modes: instantaneous, average, or peak-hold.

You can display multiple spectrum views with different channel selections and zoom factors, and see these alongside time-domain waveforms of the same data. A comprehensive set of automatic frequency-domain measurements, including THD, THD+N, SNR, SINAD and IMD, can be added to the display.

Math channels

Create new channels by combining input channels and reference waveforms. Choose from a wide range of arithmetic, logarithmic,

trigonometric and other functions. Define a function using the push-button control panel or type an equation in the text box.

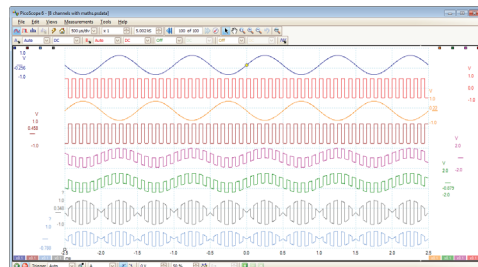

PicoScope: the display can be as simple or as complex as you need. Begin with a single view of one channel, and then expand the display to include any number of live channels, math channels and reference waveforms.

Tools > Serial decoding: Decode multiple serial data signals and display the data alongside the physical signal or as a detailed table.

Tools > Reference channels: Store waveforms in memory or on disk and display them alongside live inputs. Ideal for diagnostics and production testing.

Tools > Masks: Automatically generate a test mask from a waveform or draw one by hand. PicoScope highlights any parts of the waveform that fall outside the mask and shows error statistics.

Channel options: Filtering, offset, resolution enhancement, custom probes and more.

Auto setup button: Configures the timebase and voltage ranges for stable display of signals.

Trigger marker: Drag to adjust trigger level and pre-trigger time.

Oscilloscope controls: Controls such as voltage range, scope resolution, channel enable, timebase and memory depth are placed on the toolbar for quick access, leaving the main display area clear for waveforms.

Signal generator: Generates standard signals or (on selected scopes) arbitrary waveforms. Includes frequency sweep mode.

Waveform replay tools: PicoScope automatically records up to 10,000 of the most recent waveforms. You can quickly scan through to look for intermittent events, or use the **Buffer Navigator** to search visually.

Zoom and pan tools: PicoScope allows a zoom factor of several million, which is necessary when working with the deep memory of the 5000 Series scopes. Either use the zoom-in, zoom-out and pan tools, or click and drag in the zoom overview window for fast navigation.

Views: PicoScope is carefully designed to make the best use of the display area. You can add new scope and spectrum views with automatic or custom layouts.

Rulers: Each axis has two rulers that can be dragged across the screen to make quick measurements of amplitude, time and frequency.

Maths channels: Combine input channels and reference waveforms using simple arithmetic, or create custom equations with trigonometric and other functions.

Ruler legend: Absolute and differential ruler measurements are listed here.

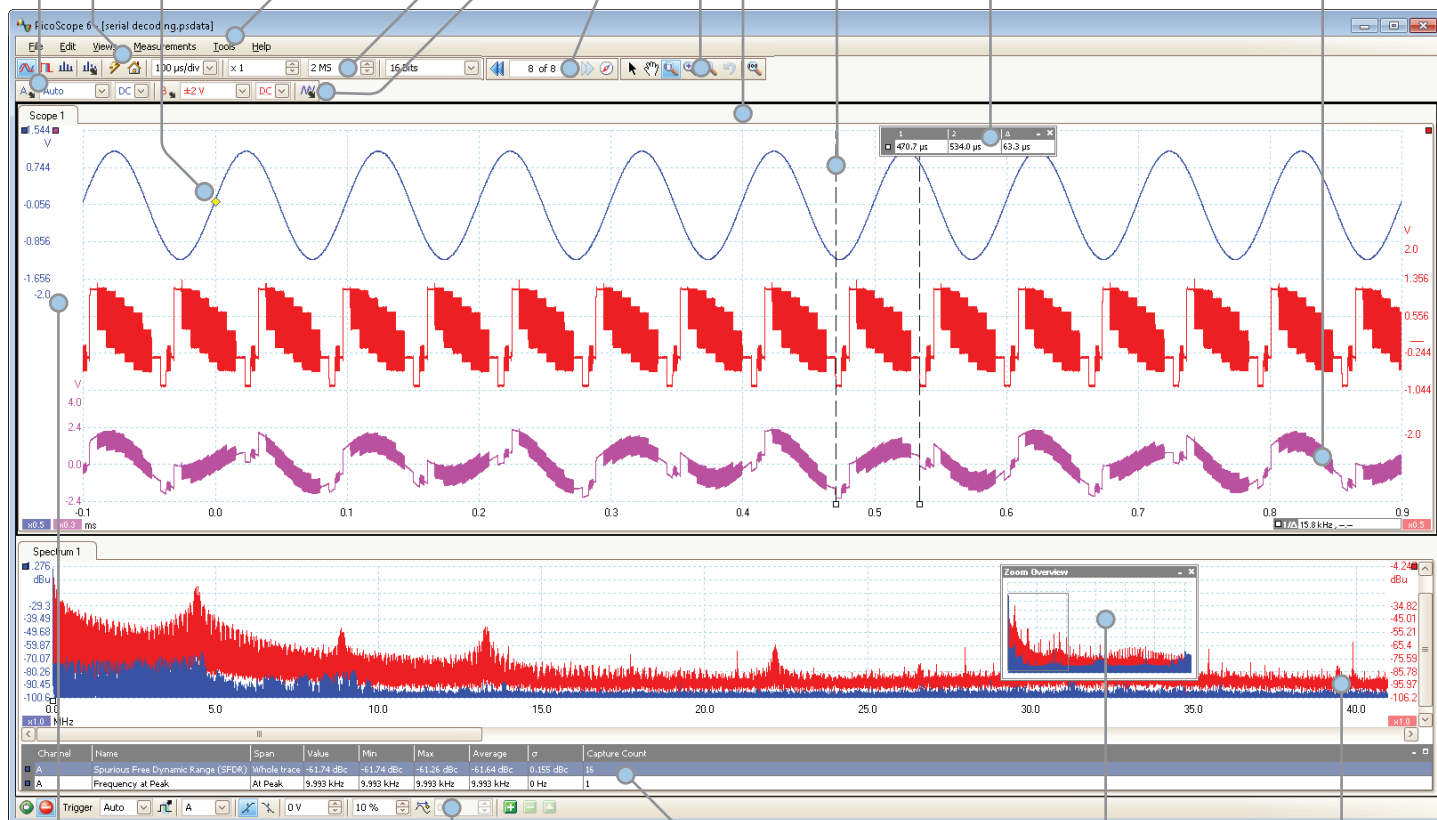

Movable axes: The vertical axes can be dragged up and down. This feature is particularly useful when one waveform is obscuring another. There's also an **Auto Arrange Axes** command.

Trigger toolbar: Quick access to main controls, with advanced triggers in a pop-up window.

Automatic measurements: Display calculated measurements for troubleshooting and analysis. You can add as many measurements as you need on each view. Each measurement includes statistical parameters showing its variability.

Zoom overview: Click and drag for quick navigation in zoomed views.

Spectrum view: View FFT data alongside scope view or independently.

PicoScope 5000 Series Specifications

VERTICAL	PicoScope 5242A	PicoScope 5442A	PicoScope 5242B	PicoScope 5442B	PicoScope 5243A	PicoScope 5443A	PicoScope 5243B	PicoScope 5443B	PicoScope 5244A	PicoScope 5444A	PicoScope 5244B	PicoScope 5444B
Number of channels	2	4	2	4	2	4	2	4	2	4	2	4
Bandwidth (-3 dB)	All modes: 60 MHz				8 to 15-bit modes: 100 MHz • 16-bit mode: 60 MHz				8 to 15-bit modes: 200 MHz • 16-bit mode: 60 MHz			
Bandwidth limiting (-3 dB)	20 MHz, switchable				20 MHz, switchable				20 MHz, switchable			
Rise time (calculated, 10% to 90%)	All modes: 5.8 ns				8 to 15-bit modes: 3.5 ns • 16-bit mode: 5.8 ns				8 to 15-bit modes: 1.8 ns • 16-bit mode: 5.8 ns			
Input connectors	BNCs on front panel				BNCs on front panel				BNCs on front panel			
Resolution*	8 bits, 12 bits, 14 bits, 15 bits, 16 bits				8 bits, 12 bits, 14 bits, 15 bits, 16 bits				8 bits, 12 bits, 14 bits, 15 bits, 16 bits			
Enhanced vertical resolution	Hardware resolution + 4 bits				Hardware resolution + 4 bits				Hardware resolution + 4 bits			
Input characteristics	1 MΩ ±1% 13 pF, ±1 pF				1 MΩ ±1% 13 pF, ±1 pF				1 MΩ ±1% 13 pF, ±1 pF			
Input coupling	AC/DC				AC/DC				AC/DC			
Input sensitivity	2 mV/div to 4 V/div				2 mV/div to 4 V/div				2 mV/div to 4 V/div			
Input ranges	±10 mV to ±20 V full scale, in 11 ranges				±10 mV to ±20 V full scale, in 11 ranges				±10 mV to ±20 V full scale, in 11 ranges			
Analog offset range	±250mV (10, 20, 50, 100, 200 mV ranges), ±2.5 V (500 mV, 1 V, 2 V ranges), ±20 V (5, 10, 20 V ranges)				±250mV (10, 20, 50, 100, 200 mV ranges), ±2.5 V (500 mV, 1 V, 2 V ranges), ±20 V (5, 10, 20 V ranges)				±250mV (10, 20, 50, 100, 200 mV ranges), ±2.5 V (500 mV, 1 V, 2 V ranges), ±20 V (5, 10, 20 V ranges)			
DC accuracy	≥ 12-bit mode: ±0.25% typical @ 25°C (±1% of full scale max @ 20 - 30°C) • 8-bit mode: ±1% typical @ 25°C (±3% of full scale max @ 20 - 30°C)											
±50 mV to ±20 V ±10 mV and ±20 mV ranges	All modes: ±2% typical @ 25°C (±5% of full scale max @ 20 - 30°C)											
Overvoltage protection	± 100 V (DC + AC peak)				± 100 V (DC + AC peak)				± 100 V (DC + AC peak)			

* Maximum effective resolution is limited on the lowest voltage ranges: ±10 mV = 8 bits • ±20 mV = 12 bits. All other ranges can use full resolution.

HORIZONTAL	PicoScope 5242A	PicoScope 5442A	PicoScope 5242B	PicoScope 5442B	PicoScope 5243A	PicoScope 5443A	PicoScope 5243B	PicoScope 5443B	PicoScope 5244A	PicoScope 5444A	PicoScope 5244B	PicoScope 5444B
Max. sampling rate	8-bit mode		12-bit mode		14-bit mode		15-bit mode		16-bit mode			
Any 1 channel	1 GS/s		500 MS/s		125 MS/s		125 MS/s		62.5 MS/s			
Any 2 channels	500 MS/s		250 MS/s		125 MS/s		-		-			
Any 3 channels	250 MS/s		125 MS/s		125 MS/s		-		-			
Four channels	250 MS/s		125 MS/s		125 MS/s		-		-			
Maximum ETS rate (8-bit mode only)	2.5 GS/s				5 GS/s				10 GS/s			
Sampling rate (USB streaming)	10 MS/s in PicoScope 6. >10 MS/s using supplied API				10 MS/s in PicoScope 6. >10 MS/s using supplied API				10 MS/s in PicoScope 6. >10 MS/s using supplied API			
Timebase ranges	2 ns/div to 1000 s/div				1 ns/div to 1000 s/div				500 ps/div to 1000 s/div			
Buffer memory** (8-bit)	16 MS		32 MS		64 MS		128 MS		256 MS		512 MS	
Buffer memory** (≥ 12-bit)	8 MS		16 MS		32 MS		64 MS		128 MS		256 MS	
Buffer memory** continuous streaming	100 MS in PicoScope software				100 MS in PicoScope software				100 MS in PicoScope software			
Waveform buffer (no. of segments)	10,000 in PicoScope software				10,000 in PicoScope software				10,000 in PicoScope software			
Timebase accuracy (drift)	±50 ppm (±5 ppm/year)				±2 ppm (±1 ppm/year)				±2 ppm (±1 ppm/year)			
Sample jitter	3 ps RMS, typical				3 ps RMS, typical				3 ps RMS, typical			

** Shared between active channels

DYNAMIC PERFORMANCE (typical; analog channels)	PicoScope 5242A	PicoScope 5442A	PicoScope 5242B	PicoScope 5442B	PicoScope 5243A	PicoScope 5443A	PicoScope 5243B	PicoScope 5443B	PicoScope 5244A	PicoScope 5444A	PicoScope 5244B	PicoScope 5444B
Crosstalk	Better than 400:1 up to full bandwidth (equal voltage ranges)											
Total harmonic distortion (THD)	8-bit mode: < -60 dB at 100 kHz full scale input • ≥ 12-bit mode: < -70 dB at 100 kHz full scale input											
SFDR	8 and 12-bit: > 60 dB at 100 kHz full scale input • 14 to 16-bit: > 70 dB at 100 kHz full scale input											
Noise (on 50 mV range)	8-bit mode 120 μV RMS • 12-bit mode 110 μV RMS • 14-bit mode 100 μV RMS • 15-bit mode 85 μV RMS • 16-bit mode 70 μV RMS											
Bandwidth flatness	(±0.3 dB, -3 dB) from DC to full bandwidth				(±0.3 dB, -3 dB) from DC to full bandwidth				(±0.3 dB, -3 dB) from DC to full bandwidth			

PicoScope 5000 Series Specifications

	PicoScope 5242A/5442A	PicoScope 5242B/5442B	PicoScope 5243A/5443A	PicoScope 5243B/5443B	PicoScope 5244A/5444A	PicoScope 5244B/5444B
TRIGGERING						
Source	All channels		All channels		All channels	
Trigger modes	None, Auto, Repeat, Single, Rapid (segmented memory)					
Advanced triggers	Edge, Window, Pulse width, Window pulse width, Dropout, Window dropout, Interval, Runt pulse, Logic					
Trigger types (ETS mode)	Rising, falling					
Sensitivity	Digital triggering provides 1 LSB accuracy up to full bandwidth of scope. • ETS mode: Typical 10 mV p-p, at full bandwidth					
Maximum pre-trigger capture	100% of capture size					
Maximum post-trigger capture	4 billion samples					
Trigger re-arm time	< 2 μ s on fastest timebase					
Maximum trigger rate	Up to 10,000 waveforms in a 20 ms burst					
EXTERNAL TRIGGER INPUT						
Trigger types	Edge, pulse width, dropout, interval, logic					
Input characteristics	Front panel BNC, 1 M Ω \pm 1% 13 pF \pm 1 pF					
Bandwidth	60 MHz		100 MHz		200 MHz	
Voltage range	\pm 5 V, DC coupled					
Overvoltage protection	\pm 100 V (DC + AC peak)					
FUNCTION GENERATOR						
Standard output signals	Sine, square, triangle, DC voltage					
Standard signal frequency	DC to 20 MHz					
Output frequency accuracy	\pm 50 ppm (\pm 5 ppm/year)		\pm 2 ppm (\pm 1 ppm/year)		\pm 2 ppm (\pm 1 ppm/year)	
Output frequency resolution	< 50 mHz					
Output voltage range	\pm 2 V with \pm 1% DC accuracy					
Output voltage adjustment	Signal amplitude and offset adjustable in approx. 0.25 mV steps within overall \pm 2 V range					
Amplitude flatness	< 2 dB to 20 MHz, typical @ 50 Ω load					
SFDR	> 70 dB, 10 kHz full scale sine wave					
Connector type	BNC, 50 Ω output impedance					
Overvoltage protection	\pm 20 V					
Sweep modes	Up, down, or alternating, with selectable start/stop frequencies and increments					
AWG (B models only)						
Output signals	-	Ramp, sinc, Gaussian, half-sine, white noise, PRBS	-	Ramp, sinc, Gaussian, half-sine, white noise, PRBS	-	Ramp, sinc, Gaussian, half-sine, white noise, PRBS
Update rate	-	200 MS/s	-	200 MS/s	-	200 MS/s
Buffer size	-	16 kS	-	32 kS	-	48 kS
Resolution	-	14 bits (output step size approximately 0.25 mV)	-	14 bits (output step size approximately 0.25 mV)	-	14 bits (output step size approximately 0.25 mV)
Bandwidth	-	> 20 MHz	-	> 20 MHz	-	> 20 MHz
Rise time (10% to 90%)	-	< 10 ns	-	< 10 ns	-	< 10 ns
PROBE COMPENSATION OUTPUT						
Output characteristics	600 Ω					
Output frequency	1 kHz					
Output level	3 V pk-pk					
Overvoltage protection	10 V					

PicoScope 5000 Series Specifications

SPECTRUM ANALYZER	PicoScope 5242A/5442A	PicoScope 5242B/5442B	PicoScope 5243A/5443A	PicoScope 5243B/5443B	PicoScope 5244A/5444A	PicoScope 5244B/5444B
Frequency range	DC to 60 MHz		DC to 100 MHz		DC to 200 MHz	
Display modes	Magnitude, average, peak hold		Magnitude, average, peak hold		Magnitude, average, peak hold	
Windowing functions	Rectangular, Gaussian, triangular, Blackman, Blackman-Harris, Hamming, Hann, flat-top					
Number of FFT points	Selectable from 128 to 1 million in powers of 2					
MATH CHANNELS						
Functions	-x, x+y, x-y, x*y, x/y, x^y, sqrt, exp, ln, log, abs, norm, sign, sin, cos, tan, arcsin, arccos, arctan, sinh, cosh, tanh, delay, average, frequency, derivative, integral, min, max, mean, peak					
Operands	A, B, C, D (input channels), T (time), reference waveforms, pi					
AUTOMATIC MEASUREMENTS						
Oscilloscope	AC RMS, true RMS, DC average, cycle time, frequency, duty cycle, falling rate, fall time, rising rate, rise time, high pulse width, low pulse width, maximum, minimum, peak to peak					
Spectrum	Frequency at peak, amplitude at peak, average amplitude at peak, total power, THD %, THD dB, THD+N, SFDR, SINAD, SNR, IMD					
Statistics	Minimum, maximum, average and standard deviation					
SERIAL DECODING						
Protocols	I ² C, I ² S, SPI, RS232/UART, CAN, LIN, FlexRay					
MASK LIMIT TESTING						
Statistics	Pass/fail, failure count, total count					
DISPLAY						
Interpolation	Linear or sin(x)/x					
Persistence modes	Digital color, analog intensity, custom, or none					
GENERAL						
PC connectivity	USB 2.0 hi-speed (USB 1.1 and USB 3.0 compatible)					
Power requirements	1 A (2 channels) from 2 USB ports (double-headed cable supplied) or 1.5 A at 5 V (up to 4 channels) from AC adaptor					
Dimensions	190 x 170 x 40 mm (including connectors)					
Weight	< 0.5 kg					
Temperature range	Operating: 0 °C to 50 °C (20 °C to 30 °C for stated accuracy). Storage: -20 °C to 60 °C.					
Humidity range	Operating: 5 %RH to 80 %RH non-condensing. Storage: 5 %RH to 95 %RH non-condensing.					
Environment	Dry locations only; up to 2000 m altitude					
Safety approvals	Designed to EN 61010-1:2010					
EMC approvals	Tested to EN61326-1:2006 and FCC Part 15 Subpart B					
Environmental approvals	RoHS and WEEE compliant					
Software/PC requirements	PicoScope 6, SDK and example programs. Microsoft Windows XP, Windows Vista, Windows 7 or Windows 8 (Windows RT not supported)					
Accessories	USB cable(s), 2 or 4 probes in probe case, AC adaptor for 4-channel scope					
Languages (full support):	English, French, German, Italian and Spanish					
Languages (UI only):	Chinese (Simplified and Traditional), Czech, Danish, Dutch, Finnish, Greek, Hungarian, Japanese, Korean, Norwegian, Polish, Portuguese, Romanian, Russian, Swedish and Turkish					

Connections

The front panels of the 2-channel PicoScope 5000 Series oscilloscopes have:

- 2 x BNC analog input channels
- 1 x BNC external trigger input
- 1 x BNC AWG/function generator output
- 1 x probe compensation output

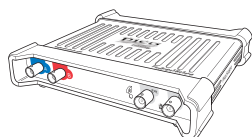

The front panels of the 4-channel PicoScope 5000 Series oscilloscopes have:

- 4 x BNC analog input channels
- 1 x BNC external trigger input
- 1 x BNC AWG/function generator output
- 1 x probe compensation output

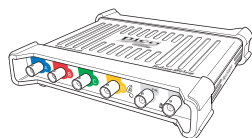

The rear panels of all oscilloscopes in the PicoScope 5000 Series have:

- 1 x DC power socket
- 1 x USB 2.0 port



Kit contents and accessories

Your PicoScope 5000 Series oscilloscope kit contains the following items:

- PicoScope 5000 Series oscilloscope
- 2 x probes (2-channel scopes)
- 4 x probes (4-channel scopes)
- Double-headed USB 2.0 cable
- Standard USB 2.0 cable (4-channel scopes only)
- Mains power adaptor (4-channel scopes only)
- Quick Start Guide
- Software and Reference CD

Probes

Your PicoScope 5000 Series oscilloscope kit comes with probes specifically trimmed to match the performance of your oscilloscope. The part numbers for these probes are as follows:



60 MHz	150 MHz	250 MHz
MI007	TA132	TA131

Ordering information

ORDER CODE	DESCRIPTION	NUMBER OF CHANNELS	BANDWIDTH	FUNC. GEN/ AWG	BUFFER SIZE	PROBES SUPPLIED	GBP	USD*	EUR*
PP863	PicoScope 5242A	2	60 MHz	Function generator	16 MS	2 x 60 MHz	699	1155	929
PP864	PicoScope 5242B	2	60 MHz	AWG	32 MS	2 x 60 MHz	799	1315	1055
PP865	PicoScope 5243A	2	100 MHz	Function generator	64 MS	2 x 150 MHz	899	1485	1195
PP866	PicoScope 5243B	2	100 MHz	AWG	128 MS	2 x 150 MHz	999	1645	1325
PP867	PicoScope 5244A	2	200 MHz	Function generator	256 MS	2 x 250 MHz	1095	1805	1455
PP868	PicoScope 5244B	2	200 MHz	AWG	512 MS	2 x 250 MHz	1195	1975	1585
PP869	PicoScope 5442A	4	60 MHz	Function generator	16 MS	4 x 60 MHz	949	1565	1255
PP870	PicoScope 5442B	4	60 MHz	AWG	32 MS	4 x 60 MHz	1095	1805	1455
PP871	PicoScope 5443A	4	100 MHz	Function generator	64 MS	4 x 150 MHz	1245	2055	1645
PP872	PicoScope 5443B	4	100 MHz	AWG	128 MS	4 x 150 MHz	1395	2305	1845
PP873	PicoScope 5444A	4	200 MHz	Function generator	256 MS	4 x 250 MHz	1545	2545	2045
PP874	PicoScope 5444B	4	200 MHz	AWG	512 MS	4 x 250 MHz	1695	2795	2245

*Prices are correct at the time of publication. Please contact Pico Technology for the latest prices before ordering.

Headquarters:

Pico Technology
James House
Colmworth Business Park
St. Neots
Cambridgeshire
PE19 8YP

United Kingdom

+44 (0) 1480 396 395

+44 (0) 1480 396 296

sales@picotech.com

US branch office:

Pico Technology
320 N Glenwood Blvd
Tyler
Texas 75702
United States

+1 800 591 2796

+1 620 272 0981

sales@picotech.com

Errors and omissions excepted. *Windows* is a registered trade mark of Microsoft Corporation in the United States and other countries. *Pico Technology* and *PicoScope* are internationally registered trade marks of Pico Technology Ltd. MM040.en-4. Copyright © 2015 Pico Technology Ltd. All rights reserved.