



DLM5000

**More channels,
more possibilities,
more insight**

**DLM5000 Series
Mixed Signal Oscilloscope**

Precision Making

Bulletin DLM5000-01EN



As the creator of the world's first 8 channel oscilloscope, and with over 100 years of industry experience, the DLM5000 is Yokogawa's latest addition to our line-up and takes you beyond 8 channels. Adaptability is a key requirement during the development of high-performance and intelligent power-semiconductor technologies and mechatronics applied in a modern electric vehicles, motor controls and energy efficient electronic designs.

Combining a large, highly responsive touchscreen and a traditional oscilloscope panel, the 4 to 8 channel DLM5000 mixed signal oscilloscope allows users to easily navigate through a wealth of analysis features at the touch of their fingertips.

Simple – With a highly responsive touchscreen, users can intuitively navigate through a variety of menus, access zoom features, and search for and identify specific events in a waveform, while still having access to the traditional oscilloscope control panel. The DLM5000 is compact 8-channel scope, making it ideal for your laboratory and design environments.

Adaptable – With up to 8 analog channels and 32 bits of logic, along with additional math channels, vehicle serial bus, and other analysis features, the DLM5000 provides the flexibility users need to capture every measurement. Additionally, DLMsync supports multi-unit synchronization extending measurements up to 16 channels to gain even more application insights.

Dependable – Yokogawa is committed to measurement quality, and the DLM5000 features low residual noise, extensive voltage ranges and a variety of real-time low pass filters to ensure signal fidelity. The history memory allows users to save and analyze each trigger captured, ensuring no data will be lost. Its purpose-built operating system makes the DLM5000 stable and reliable.



1.6 MHz
POWER SUPPLY SWITCHING FREQUENCY

0.35 WATT
POWER LOSS

500 kbps
CAN BUS BIT RATE

145^H
CAN IDENTIFIER

19.2 kbps
CXPI BUS BIT RATE

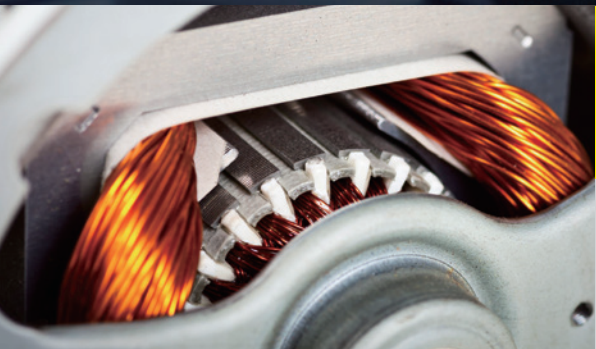

89kWh LITHIUM-ION BATTERY PACK

74.235 %

38,266.596 +
TIME BEFORE NEXT CHARGE



LITHIUM ATOM



LITHIUM-ION BATTERY

465,553.57 km
SUBURBAN MAXIMUM RANGE

14.6 Wh/100km
POWER LOSS

40.28°C
BATTERY TEMPERATURE

Basic functions ideal for circuit evaluation/software debugging

8 Analog ch + 32 bits of logic are collectively measured by one unit.

A single DLM5000 has 8 analog channels and 32 bits of logic, which usually requires two mixed signal oscilloscopes. By viewing sensor signals and amplifier inputs and outputs on the analog channels and serial/parallel bus signals on the logic channel, one unit is sufficient for embedded system debugging. The 4 ch model has been newly added to the series lineup.

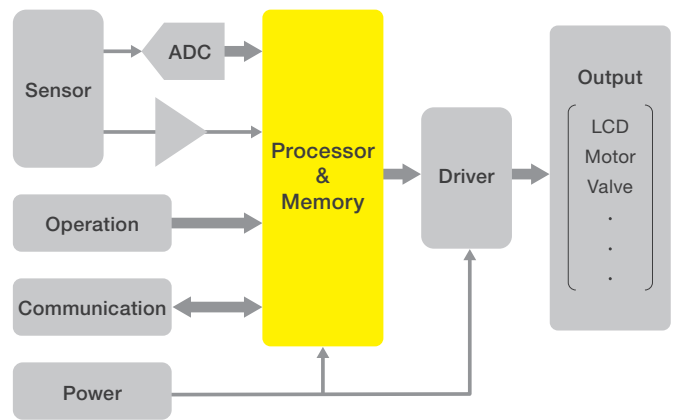
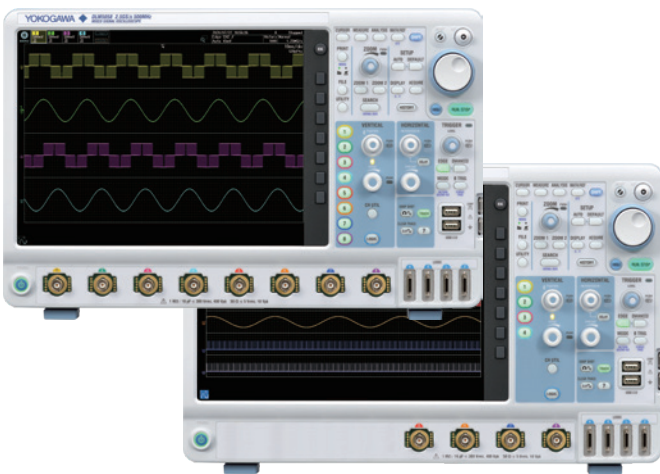

12.1 inch large screen provides a comfortable debugging environment

Equipped with a 12.1-inch large touch screen. The large screen is useful for observing analog signals in detail and displaying information for debugging, such as parameters, zoom screen, XY display, and FFT analysis results.

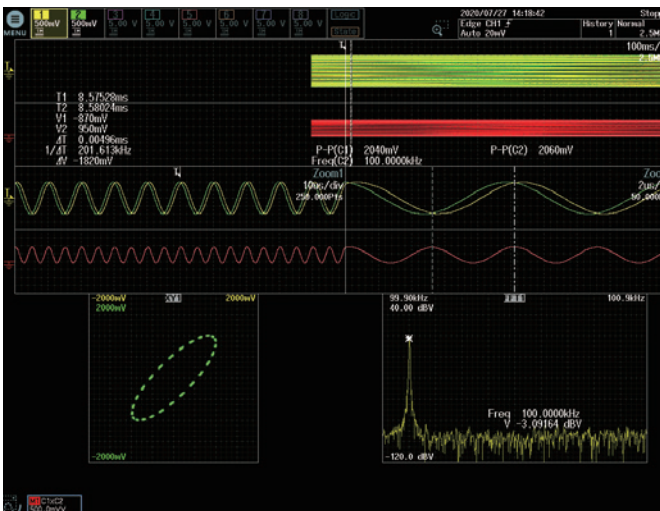

Easy to carry and measures quickly

While the DLM5000 is a large screen model with multi-channel inputs, it comes in a portable, thin & lightweight design. The instrument starts up from OFF to waveform display in 18 seconds. You can start measurement work immediately.

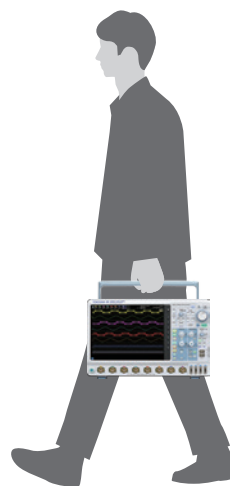

Portable

DLM5000

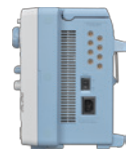

180 mm

DLM3000



193 mm

Modest 180 mm depth
Thinner than the 193 mm DLM3000

Up to 2.5 GS/s (8 channels at the same time) Up to 500 Mpoints long memory

The evaluation of an embedded system requires the verification of its operation over a relatively long period of time with software commands and the simultaneous viewing of waveforms of high-speed signals such as clock noise.

The DLM5000 is equipped with a memory that allows waveform capture of 50 Mpoints in single mode/12.5 Mpoints in repeat mode. You can observe waveforms with very few omissions.

If 500 Mpoints memory (optional) is installed, 0.2 seconds waveform can be captured even at 2.5 GS/s sample rate.

Sample rate is too low.

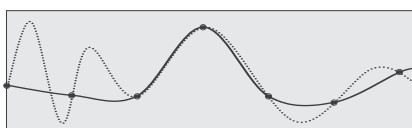

Sample rate is fairly high.

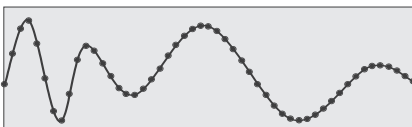

More memory is needed to use higher sample rates and capture the most accurate waveform representation.

Relationship between measuring time and sample rate in for 500 Mpoints

Sample rate	Maximum measuring time
2.5 GS/s	0.2 s
250 MS/s	2 s
25 MS/s	20 s
2.5 MS/s	200 s
250 kS/s	2000 s
100 kS/s	5000 s

Maximum record length (Points)

	Repeat	Single (when odd ch only)
Standard model	12.5 M	50 M (125M)
/M1 or /M1S	25 M	125 M (250 M)
/M2 or /M2S	50 M	250 M (500 M)

Two-unit connection function “DLMsync” in response to the request for more channels (option: coming soon)

Connecting two DLM5000s with a dedicated cable enables synchronous measurement of up to 16 analog channels. Captured waveforms are displayed on each unit. Triggers operate in common, and common items, such as memory length, sampling rate, acquisition settings and horizontal axis scale settings, are linked, so they can be used like a single 16-channel oscilloscope. You can connect 4 ch models too, so “8 + 4 = 12 channels” or “4 + 4 = 8 channels” is also possible.

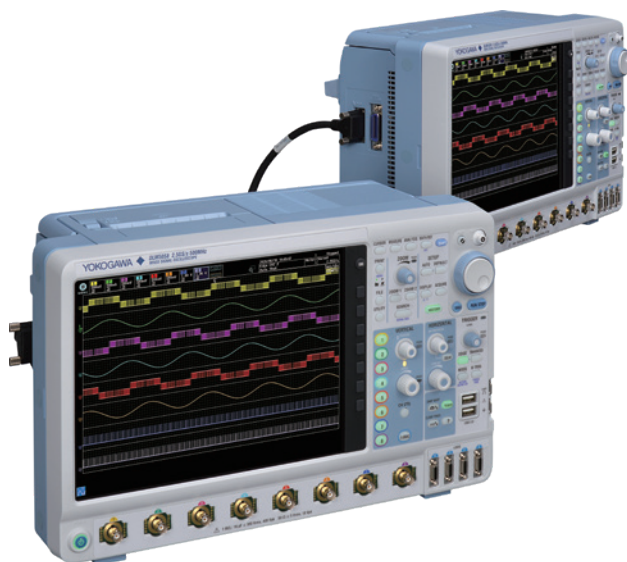

Connecting two DLM5000s with a dedicated cable enables synchronous measurement of up to 16 analog channels. Captured waveforms are displayed on each unit. Triggers operate in common, and common items, such as memory length, sampling rate, acquisition settings and horizontal axis scale settings, are linked, so they can be used like a single 16-channel oscilloscope.



Multi-channel measurement application

Motor control & inverter circuit development

4 ch **Limitation of 4 ch scope**
 Whole-system measurement is impossible with a four channel scope; the real difficulty is measuring the timing between IGBT gate signals within the inverter. Voltage and current measurements between 3 phases and the IO of the motor driver IC is a very challenging test with a four channel scope. The truly practical solution is an eight channel MSO.

Electronic control unit & mechatronic test

4 ch **Limitation of 4 ch MSO**
 The additional logic inputs of a four-channel MSO mixed signal oscilloscope provides enough channels, but this method has a blind-spot. Digital waveform analysis using logic inputs alone cannot reveal anomalies such as voltage drift, noise, distortion or ringing, and measure rise-fall times. ECU testing requires stringent examination of all digital waveforms – and analog input channels are the best tool for the job.

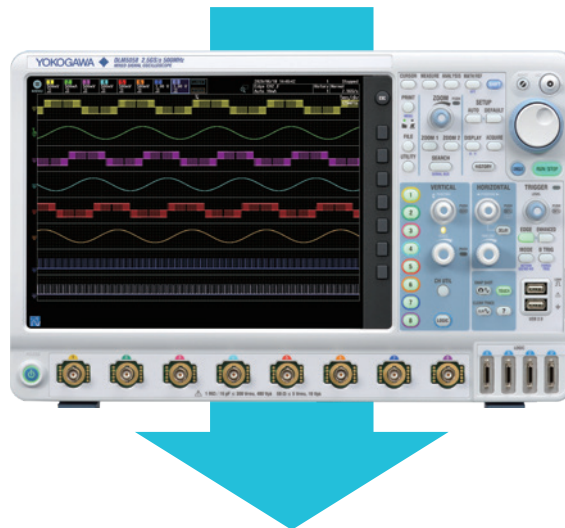

8 ch The key to efficient and reliable high performance electric motors is the modern inverter design, or 'Intelligent Power Module'. Multi-channel, high-speed waveform measurement is an absolute necessity. Four channels are simply not enough. Boasting eight true analog inputs, the DLM5000 empowers today's engineer with a convenient and comprehensive measurement system.

8 ch Numerous I/O analog, digital, and serial-bus waveforms surrounding the Electronic Control Unit (ECU) must be measured. The DLM5000 offers ample channel-count and architecture to monitor eight analog channels and up to 32-bits of logic input while simultaneously performing protocol analysis such as UART, I²C, SPI, CAN, CAN FD, LIN, CXPI and FlexRay. The DLM5000 can speed up the R&D process when four channels are not enough.

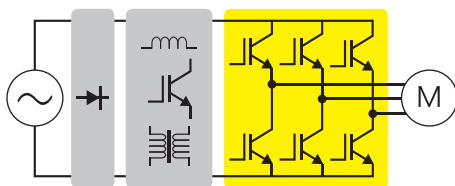

Example: 3 voltage & 3 current measurements of a 3-phase motor
 Measurement of the gate-drive signals of six IGBTs within the inverter

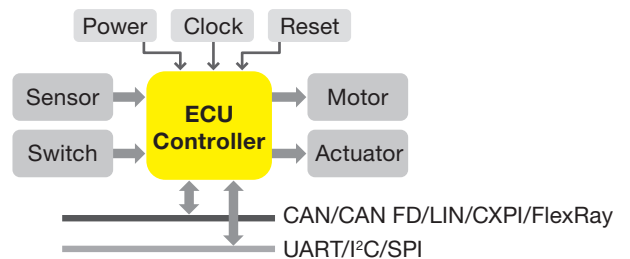

Example: Analog I/O and serial bus controller signals Stringent real time test of digital waveforms in the analog domain.

DLM5000's functions and features

You can replay waveforms later on, so you'll never miss an abnormal waveform

Original history function

Automatically save previously captured waveforms

With the DLM5000 series, up to 100000 previously captured waveforms can be saved in the acquisition memory. With the History function, you can display just one or all of the previously captured waveforms (history waveforms) on screen.

You can also perform cursor measurement, computation, and other operations on history waveforms. Using the History function, you can analyze rarely-occurring abnormal signals even when an appropriate trigger condition is hard to find because its waveform shapes are not constant.

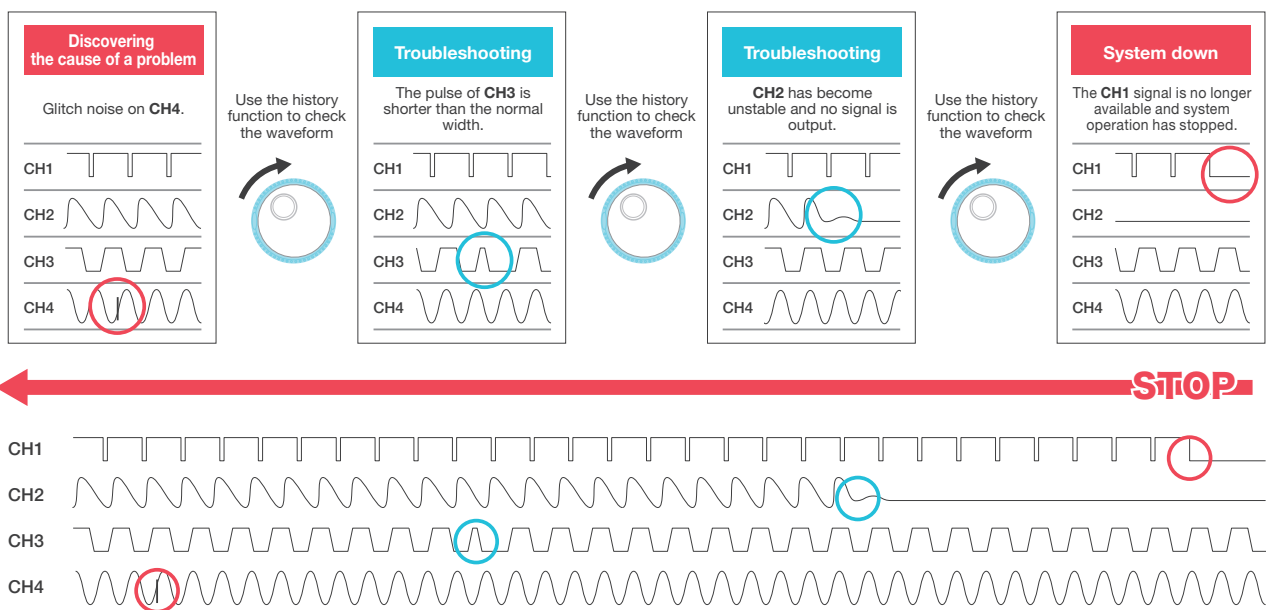

History search function

Various and powerful search methods are available to search up to 100000 waveforms for events meeting your custom requirements.

Intuitive and simple waveform search functions are provided. For example, you can specify a rectangular zone that captures a part of a waveform on the screen, a zone that covers an entire measured waveform, or a polygonal zone. If you know a value of interest, such as an abnormal value of voltage or pulse width, you can search history waveforms using waveform parameters.

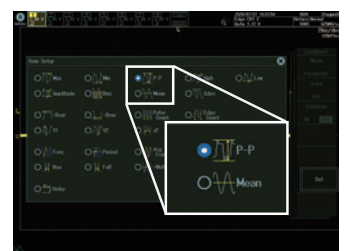
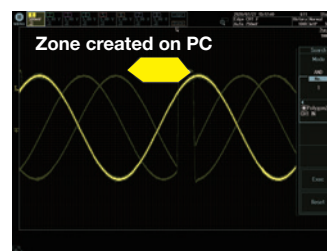
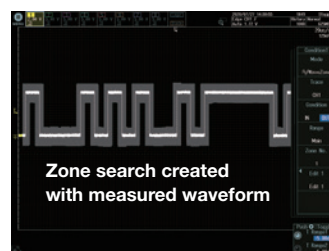
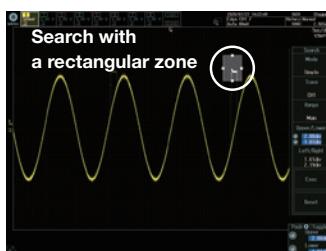

Zoom & search function

Multi-channel waveforms captured in the long memory need to be zoomed in vertically and horizontally for detailed viewing. The DLM5000 has the dedicated zoom keys and knob, allowing you to quickly zoom in on the part you want to see. You can also specify the area you want to zoom in on by using the the touch screen.

Zoom two locations simultaneously

You can display two zoomed waveforms with different time axis scales at the same time. Also, use Auto Scroll to sweep the zoom window across the waveforms automatically. Being able to zoom in on two distant locations at the same time, such as “cause” and “effect” of a certain event, or to display them with different zoom factors is very useful for software debugging.

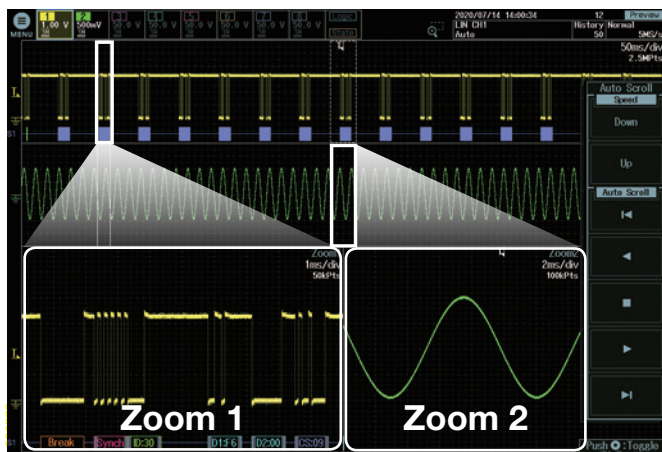

Zoom Search function

Use several search criteria to automatically find and zoom into features in the waveform for further inspection. The locations of the found waveforms are marked on screen (▼shows the current location).

Waveform search criteria

Edge, edge (qualified), state/pattern, pulse width, state width, serial bus (only on models with the serial bus analysis option)

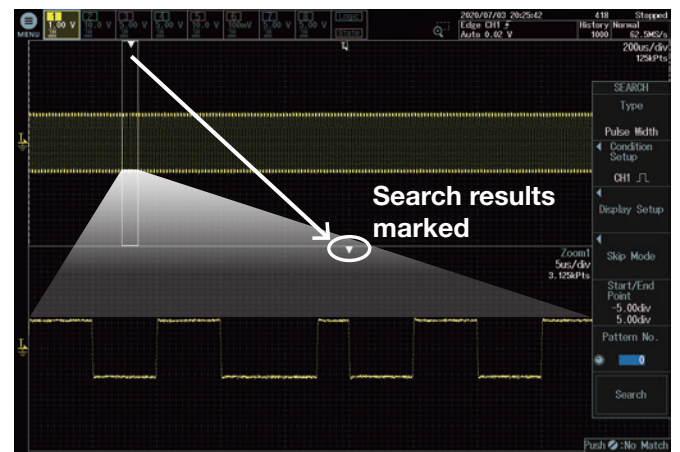

Waveform search using edge criterion

Touchscreen

By using the touchscreen to move the waveform position, change the scale, move the cursor, and such, you can operate the instrument without taking your eyes off the waveform.

If you want to zoom in a part of the waveform, use Rect Zoom for easy zooming by swiping your finger diagonally across the screen to specify the area.

To select items on the dialog box, you can directly touch them, which eliminates the trouble of using select keys.

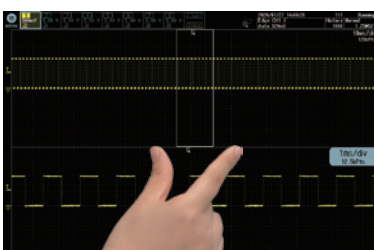

Changing zoom ratio by pinching in and out

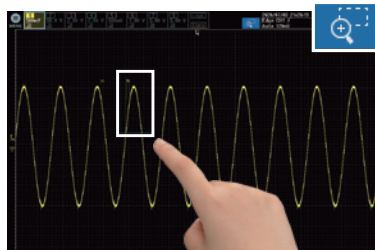

Rect Zoom



Selecting waveform parameter items

Large selection of triggers – Trigger function captures combined analog/digital complex waveforms –

The DLM5000 series comes with a variety of easy-to-configure triggers combining analog and logic inputs such as edge, enhanced, and B triggers. By using a digital trigger system, trigger errors are minimized.

Trigger types

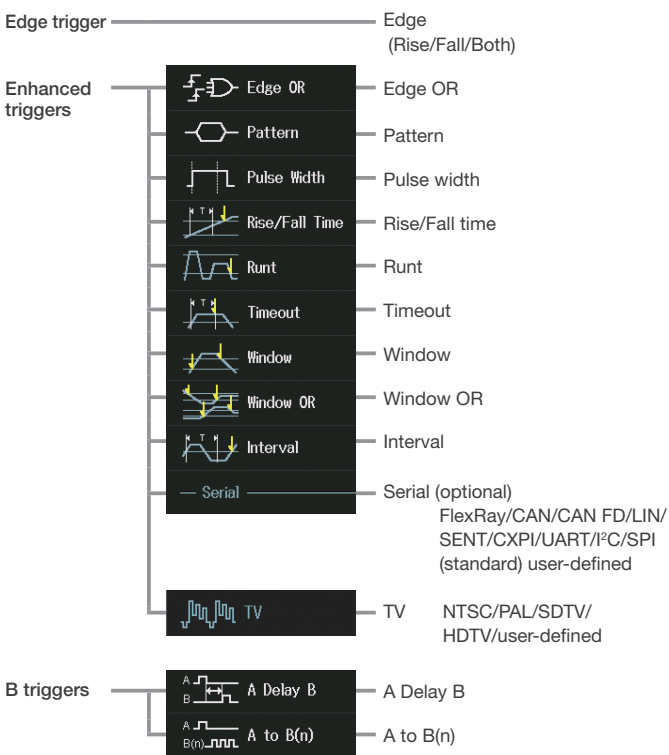

Runt trigger

In a circuit that synchronizes external input signals with a clock, metastable phenomena can cause problems, such as narrowing the pulse width or generating abnormal waveforms where the signal level does not reach the specified value. A runt trigger is useful to trigger on such phenomena. Runt trigger can be used to trigger on a constant pulse train, for example, when the signal level does not rise to the specified high level and then falls to the specified level. It detects and triggers a halfway pulse (runt pulse) that has fallen to a low level.

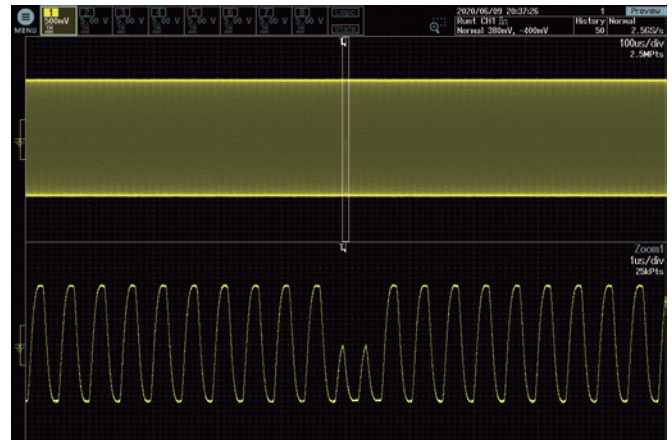

Triggers on multiple channels (Edge OR / Pattern)

Multiple channels can be monitored simultaneously and triggered by the timing of any edge change or a combination of High and Low conditions.

Edge OR trigger

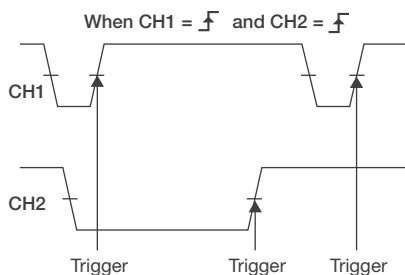

Although normal edge trigger targets only one channel, edge OR trigger targets all input channels and can be triggered when there is a change in any of them. This is a powerful tool in cases where it is not possible to specify in advance which channel the change will occur.

Triggers on a range set by upper level and lower level. (Window)

It sets two signal levels, an upper and lower limit, and triggers on the condition of whether or not it is IN / OUT of range and how long it stays in that range.

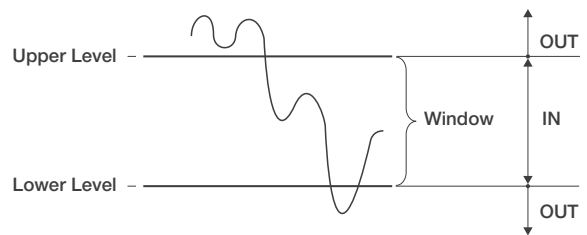

In case of normal edge trigger, only one level can be set, but in case of window trigger, two levels can be set, Upper and Lower. This is very useful for checking whether the voltage is within the upper and lower limits.

Filter functions

Real time filter with optimum noise reduction supports a wide range of frequencies – from 8 kHz to 200 MHz – Each channel has 14 low pass filters available with cutoff frequencies from 8 kHz to 200 MHz. Waveforms are filtered prior to storage in memory. Real-time filters allow for stable triggering of superimposed noise signals.

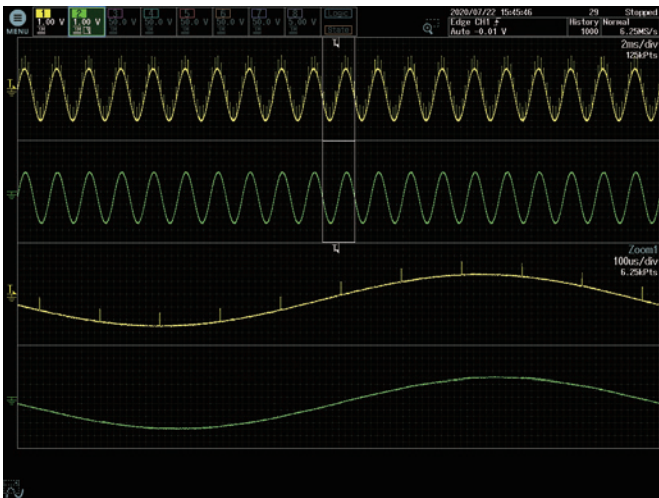

Processing with Real time filters

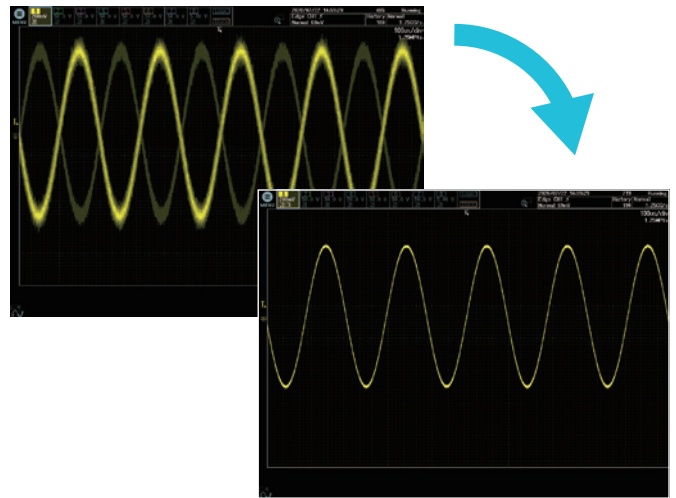

Stable trigger as a result of noise reduction

Logic signal measurement and analysis

The flexible MSO inputs are included as standard. This enables the DLM5000 to be converted to a 8 analog and 16 digital input MSO. With the /L32 option, up to 32 logic signals can be measured. Bus/State display and optional DA calculation function, which is useful for evaluating AD/ DA converters, are also provided.

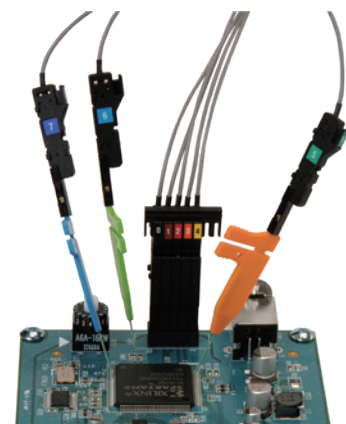
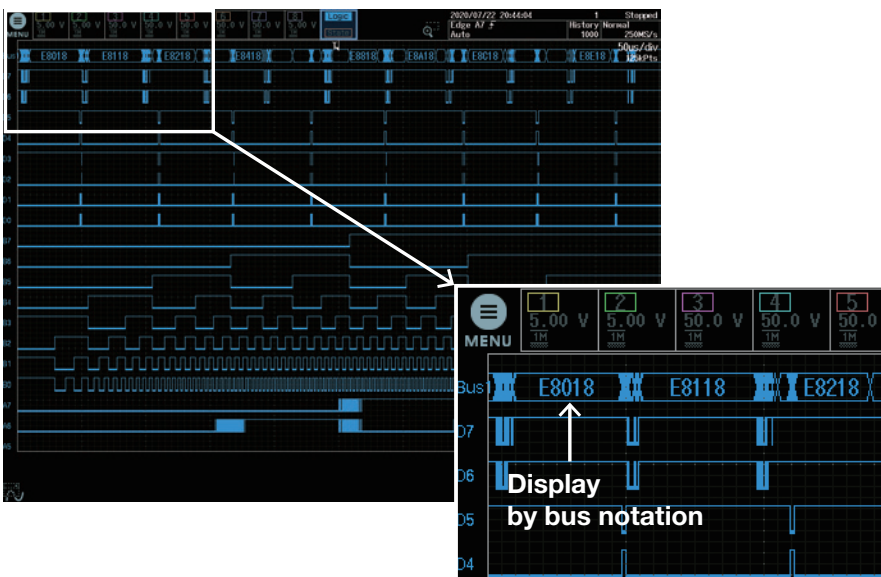

Features designed for productivity

Measure function and statistics

Twenty-nine waveform parameter measurements are included. Automated measurement of up to 30 simultaneous measurements is available. Statistical values can also be measured continuously, cycle-by-cycle or using history memory. In addition, cycle-by-cycle parameter measurement is possible to calculate fluctuations of a captured waveform.

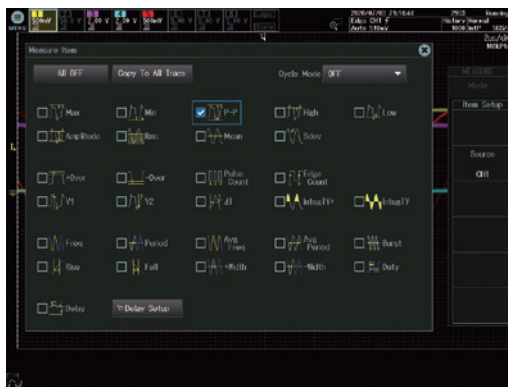

FFT analysis

Up to 4 FFT analyses can be performed simultaneously. FFT can be performed on computed waveforms in addition to the actual waveforms on CH1 to CH8. The peak detection function that automatically detects the spurious frequency is a useful feature for searching for a noise source, such as clock and power supply switching noise.

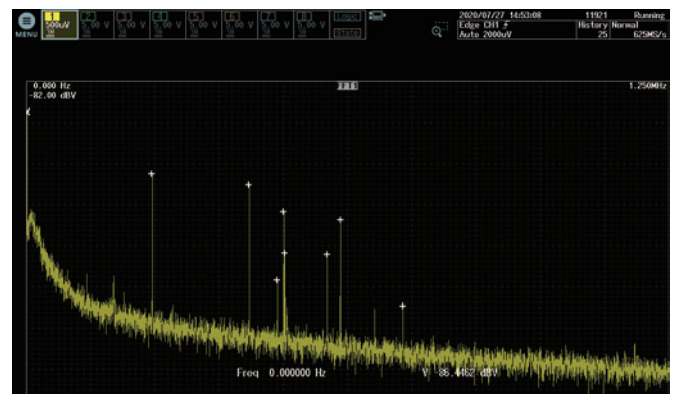

Statistical calculation of waveform parameters

For repetitive waveforms, a large number of periodic waveforms are captured on the memory. The DLM5000 can statistically analyze the parameters of repetitive waveforms. Jitter measurement and level fluctuation analysis are possible.

Normal statistical processing

The waveform parameters for each successive trigger are calculated and statistically processed.

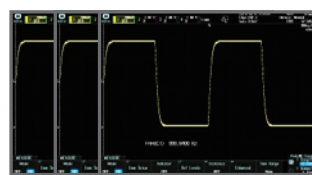

Statistical Processing of History Waveforms

Calculates and statistically processes the waveform parameters of each trigger waveform in history memory.



Cyclic Statistical Processing

The waveform displayed on the screen is divided into each cycle and the waveform parameters are calculated and statistically processed individually.

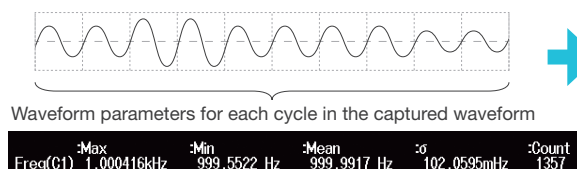

Histogram Display

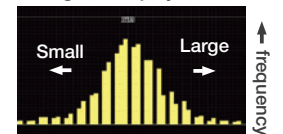

Trend Display

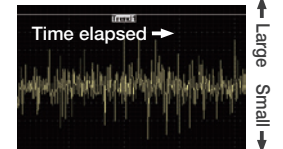

CSV format file

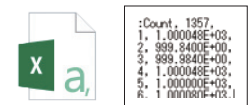

Waveform parameter statistics

- Maximum / Minimum
- Mean / Standard deviation

Snapshot

By pressing the “camera” key to the lower right of the screen, you can freeze a white trace of the currently displayed waveform on the screen. You can press the key repeatedly and conveniently leave traces for comparing multiple waveforms.



Thumbnails of saved files

Display thumbnails of saved waveforms, waveform images, and Wave Zone files for easier browsing, copying or deleting. A full-size view shows even more details.

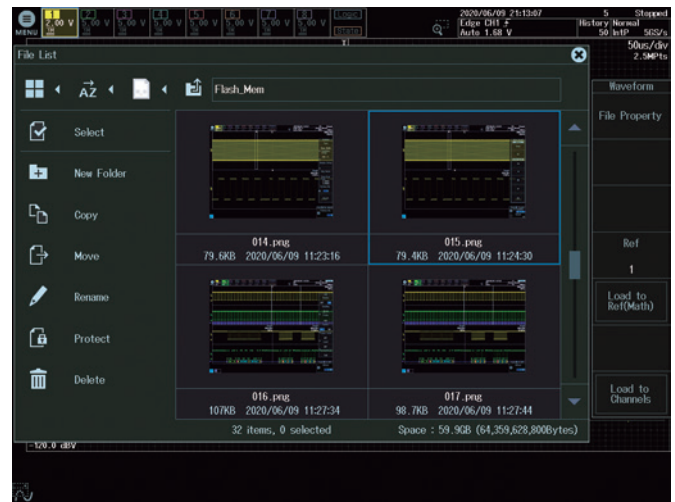

Action on trigger, GO/NO-GO

GO/NO-GO automates pass or fail determination for trigger conditions, waveforms, measured parameters, and other criteria. Actions automate buzzer sounds, file saving, or email notification. Waveforms in which an abnormality occurred can be saved for confirmation and analysis of the phenomena at a later time.

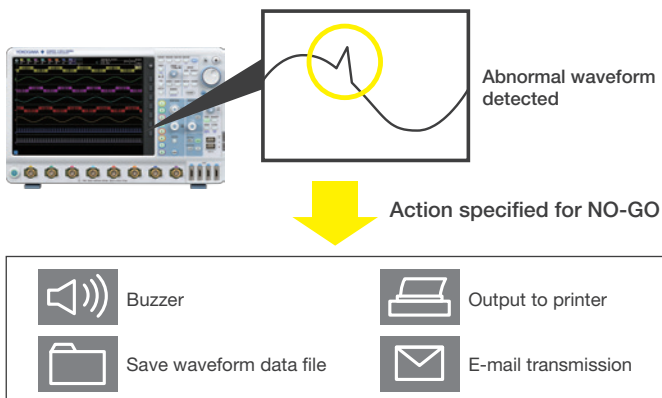

Graphical online help

Get help without having to find the user manual. Pressing the “?” key opens detailed graphical explanations of the oscilloscope’s functions.

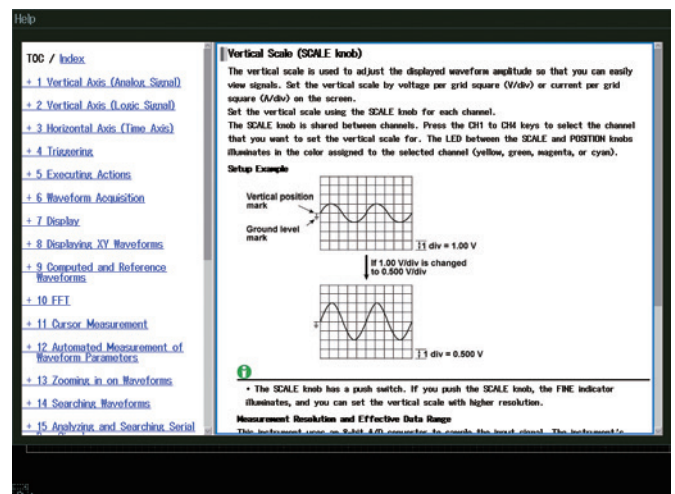

Application-specific analysis options

Serial analysis function options (/F01 to /F05)

UART (RS232) /I²C/SPI/CAN/CAN FD/LIN/FlexRay/SENT/CXPI

Dedicated trigger and analysis options are available for various serial buses of both in-vehicle and embedded systems. Logic input can also be used for I²C/SPI/UART/SENT. When it is not necessary to observe waveform quality of a bus, decoding or analysis using logic inputs is possible.

Unique auto setup

Yokogawa's proprietary auto setup function automatically analyzes the input signal and complex parameters such as bit rate and threshold level, selecting the optimal settings in seconds. This feature not only saves time but is also a powerful debugging feature when the bit rate and other parameters are unknown.

Simultaneous analysis of up to 4 buses

Perform high-speed simultaneous analysis on up to four different serial buses operating at different speeds. Extensive search capabilities enhance the usability, allowing the user to find specific data in the very long memory. The dual-zoom facility means that different buses can be viewed and debugged alongside each other.

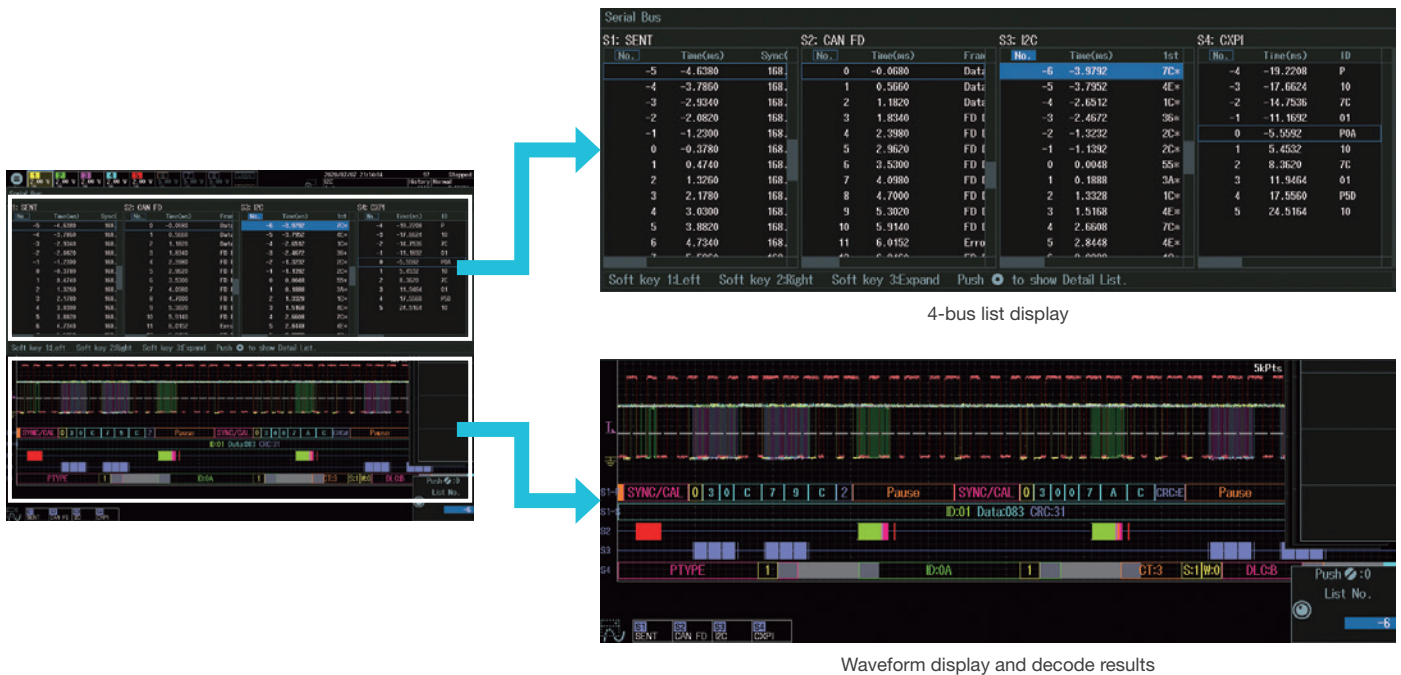

Related accessories (sold separately)

Differential probe PBDH1000 (701924)

DC to 1.0 GHz bandwidth 1 MΩ, approximately 1.1 pF
Maximum differential input voltage range: ±25 V



Logic probe PBL100/PBL250 (701988/701989)

100 MHz/250 MHz toggle frequency 1 MΩ, 10 pF/100 kΩ, 3 pF

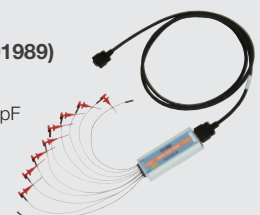

User defined math option (/G02)

Equations can be arbitrarily created using a suite of operators such as trigonometric and logarithmic operators, integration and differentiation, pulse width operators, phase measurement and digital to analog conversion.

Power supply analysis option (/G03)

Switching loss analysis

Calculate switching loss $[V(t) \times i(t)]$ over long test cycles utilizing the long built-in memory. A wide variety of switching loss analyses are supported, including turn-on/off loss calculation, loss including continuity loss, and loss over long cycles of 50 Hz/60 Hz power line.

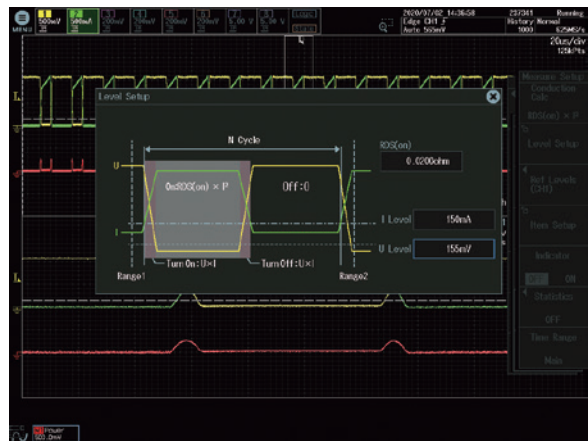

Power parameter measurement

Measure power parameters automatically for up to two pairs of voltage and current waveforms, such as active power, apparent power, power factor, and more. Cycle statistics and history statistics can also be calculated.

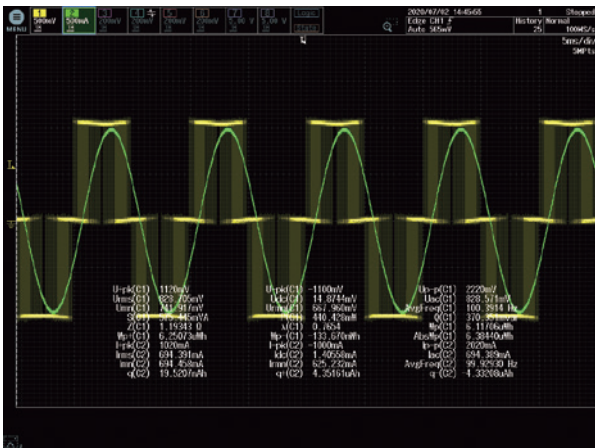

Related accessories (sold separately)

Differential probe PBDH0150 (701927)

DC to 150 MHz
1000 Vrms/ ±1400 Vpeak

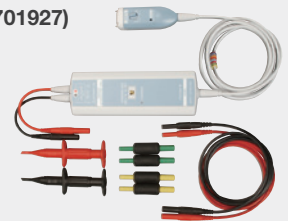

Current probe PBC100/PBC050 (701928/701929)

DC to 100 MHz (701928)
DC to 50 MHz (701929)
30 Arms

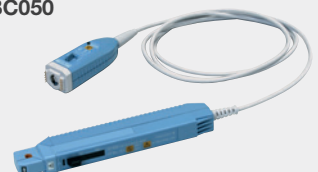

Intuitive control panel and connectivity

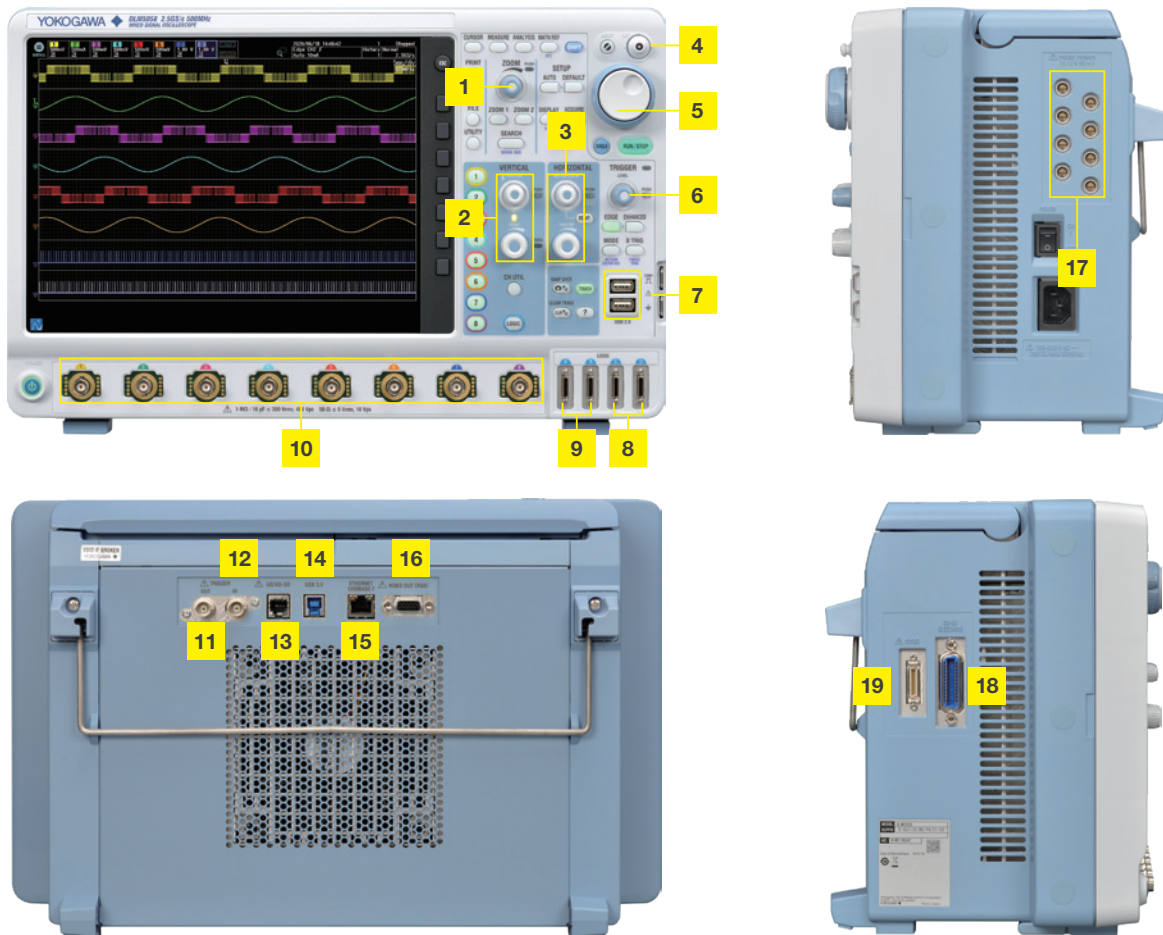

* The photo shows the 8-channel model.

- | | |
|--|--|
| 1 Dedicated Zoom Knob | 11 External trigger output |
| 2 Vertical Position and Scale Knob | 12 External trigger input |
| 3 Horizontal Position and Scale Knob | 13 GO/NO-GO output terminal |
| 4 Four-Direction Selector Button Select key moves the cursor up/down/left/right | 14 USB-PC connection terminal |
| 5 Jog Shuttle and Rotary Knob | 15 1000 BASE-T Ethernet |
| 6 Dedicated Trigger Level Knob | 16 RGB video output terminal |
| 7 USB peripheral connection terminal × 2 | 17 Probe power supply terminal × 8 (optional) ² |
| 8 Logic input connector 16 bit (optional) | 18 GP-IB connection terminal (optional) |
| 9 Logic input connector 16 bit (standard) | 19 Synchronous operation terminal (for DLMsync ³) |
| 10 Eight Analog Input Channels ¹ | |

¹: Four ch model has 4 analog inputs

²: Four ch model has 4 terminals

³: Option is required for feature activation

Wide range of interfaces and software

Increase work efficiency by using PC

Gigabit Ethernet and USB 3.0^{*1} as standard communication interfaces

DLM5000's long memory is useful for suppressing failure in capturing waveforms, such as the history function, but it takes time to transfer data to a PC.

With the standard-equipped Gigabit Ethernet and USB 3.0, the DLM5000 is approximately 10 times faster at saving data to the internal storage and at transferring data to a PC.^{*2}

Get answers faster, even with large data sets.

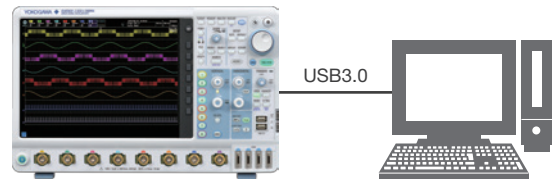

*1: USB function only. USB host function uses USB 2.0 communication.
 *2: When /C8 option (SSD) is installed for internal storage and USB 3.0 mass storage connection is used for transfer.
 Compare with the conventional model (DLM4000).

Purpose-built operating system to realize stability and reliability

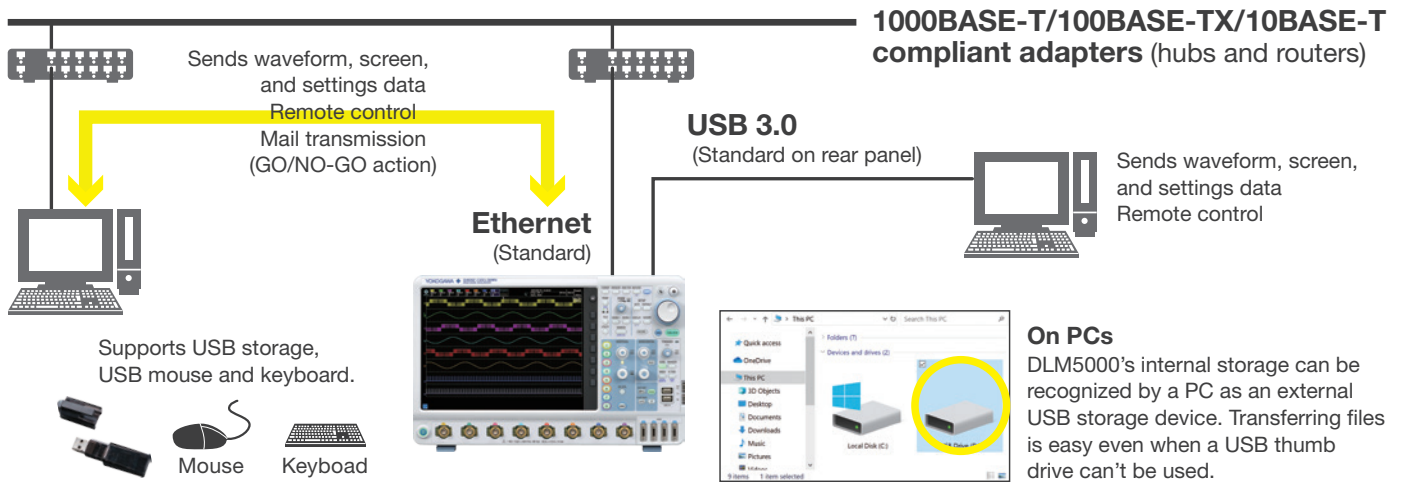

Software Control

Free Software

Optional Software Trial version available

Off-line waveform display and analysis	XviewerLITE –Basic viewing– Zoom, V-cursor, conversion to CSV format	Xviewer –Advanced Analysis– Advanced and useful functions are supported. Good for precise, off-line waveform analysis. <ul style="list-style-type: none"> • Waveform observation and analysis • Cursor, Parametric Measure • Statistical Analysis • Multiple file display • Advanced waveform operations • Comment, marking, printing and making report • Optional Math computation feature • Remote monitor • Instruments communication function • Transferring waveform & image files
Waveform monitoring on a PC	XWirepuller Remote monitor and operation Transferring image files	
Data transfer to a PC		
Command control Custom software development	Control library "TMCTL" For Visual Studio	*1, *2: Coming soon *1: Program development environment provided by National Instruments (NI) *2: MathWorks's product. *3: DLM5000 will be supported soon.
	DL-Term Interactive tool LabVIEW instrument driver ^{*1 *3} MATLAB ^{*2 *3} WDF Access ToolBox Transfer data file to MATLAB	

Specifications

(On the 4-channel model, CH8 should be read as CH4 and M8 should be read as M4.)

Models				
Model name	Frequency bandwidth	Analog input	Logic input	Max. sample rate
DLM5038	350 MHz	8 channels	16 bit (Standard) or 32 bit (L32)	2.5 GS/s
DLM5058	500 MHz			
DLM5034	350 MHz	4 channels		
DLM5054	500 MHz			

Analog Signal input				
Input channels	DLM50x8: CH1 to CH8 DLM50x4: CH1 to CH4			
Input coupling setting	AC 1 M Ω , DC 1 M Ω , DC 50 Ω			
Input impedance	Analog input			
	1 M Ω	$\pm 1.0\%$, approximately 16 pF		
	50 Ω	$\pm 1.0\%$ (VSWR 1.4 or less, DC to 500 MHz)		
Voltage axis sensitivity setting range	1 M Ω	500 $\mu\text{V}/\text{div}$ to 10 V/div (steps of 1-2-5)		
	50 Ω	500 $\mu\text{V}/\text{div}$ to 1 V/div (steps of 1-2-5)		
Max. input voltage	1 M Ω	Must not exceed 300 Vrms or 400 Vpeak		
	50 Ω	Must not exceed 5 Vrms or 10 Vpeak		
Max. DC offset setting range	1 M Ω	500 $\mu\text{V}/\text{div}$ to 50 mV/div ± 1 V		
		100 mV/div to 500 mV/div ± 10 V		
		1 V/div to 10 V/div ± 100 V		
	50 Ω	500 $\mu\text{V}/\text{div}$ to 50 mV/div ± 1 V		
		100 mV/div to 1 V/div ± 5 V		
Vertical-axis (voltage-axis) DC accuracy ¹	500 $\mu\text{V}/\text{div}$	$\pm(3.0\%$ of 8 div + offset voltage accuracy)		
	1 mV/div to 10 V/div	$\pm(1.5\%$ of 8 div + offset voltage accuracy)		
Offset voltage accuracy ¹	500 μV to 50 mV/div	$\pm(1\%$ of setting + 0.2 mV)		
	100 mV to 500 mV/div	$\pm(1\%$ of setting + 2 mV)		
	1 V to 10 V/div	$\pm(1\%$ of setting + 20 mV)		
Frequency characteristics (-3 dB attenuation when inputting a sinewave of amplitude ± 3 div) ^{1,2}		DLM503x	DLM505x	
1 M Ω (when using attached 10:1 passive probe)	20 mV to 100 V/div	350 MHz	500 MHz	
	10 mV/div	350 MHz	350 MHz	
	5 mV/div	200 MHz	200 MHz	
50 Ω	2 mV to 1 V/div	350 MHz	500 MHz	
	1 mV/div	350 MHz	350 MHz	
	500 $\mu\text{V}/\text{div}$	200 MHz	200 MHz	
Isolation between channels	Maximum bandwidth: -34 dB (typical value)			
Residual noise level ³	The larger of 0.2 mVrms or 0.05 div rms (typical value)			
A/D resolution	8 bit (25 LSB/div) Max. 12 bit (in High Resolution mode)			
Bandwidth limit	FULL, 200 MHz, 100 MHz, 20 MHz, 10 MHz, 5 MHz, 2 MHz, 1 MHz, 500 kHz, 250 kHz, 125 kHz, 62.5 kHz, 32 kHz, 16 kHz, 8 kHz (can be set for each channel)			
Maximum sample rate	Real time sampling mode 2.5 GS/s			
	Repetitive sampling mode 250 GS/s			
Maximum record length (Points)		Repeat	Single (when odd ch only)	
	Standard model	12.5 M	50 M (125M)	
	/M1 or /M1S	25 M	125 M (250 M)	
	/M2 or /M2S	50 M	250 M (500 M)	
Ch-to-Ch deskew	± 1 μs			
Time axis setting range	1 ns/div to 500 s/div (steps of 1-2-5)			
Time base accuracy ¹	± 2.5 ppm (at shipping or calibration), ± 1.0 ppm/year (ageing)			
Dead time in N Single mode	Approx. 0.9 μs			
Logic Signal Input				
Number of inputs	16 bit (L32: 32 bit)			
Maximum toggle frequency ¹	Model 701988: 100 MHz, Model 701989: 250 MHz			
Compatible probes	701988, 701989 (8 bit input)			
Min. input voltage	701988: 500 mVp-p, 701989: 300 mVp-p			
Input range	Model 701988: ± 40 V Model 701989: threshold ± 6 V			
Max. nondestructive input voltage	Model 701988: ± 42 V (DC + ACpeak) or 29 Vrms Model 701989: ± 40 V (DC + ACpeak) or 28 Vrms			
Threshold level setting range	Model 701988: ± 40 V (setting resolution of 0.05 V) Model 701989: ± 6 V (setting resolution of 0.05 V)			
Input impedance	701988: Approx. 1 M Ω /approx. 10 pF 701989: Approx. 100 k Ω /approx. 3 pF			
Maximum sampling rate	1.25 GS/s			

Maximum record length (Points)	Repeat		Single
	Standard	12.5 M	50 M
/M1 or /M1S	25 M	125 M	
/M2 or /M2S	50 M	250 M	

Triggers		
Trigger modes	Auto, Auto Level, Normal, Single, N-Single, Force trigger	
Trigger type, trigger source	A triggers	
Edge	CH1 to CH8, Logic, EXT, LINE	
Edge OR	CH1 to CH8	
Pulse Width	CH1 to CH8, Logic	
Timeout	CH1 to CH8, Logic	
Pattern	CH1 to CH8, Logic	
Runt	CH1 to CH8	
Rise/Fall Time	CH1 to CH8	
Interval	CH1 to CH8, Logic	
Window	CH1 to CH8	
Window OR	CH1 to CH8	
TV	CH1 to CH8	
Serial Bus	I ² C (optional)	CH1 to CH8, Logic
	SPI (optional)	CH1 to CH8, Logic
	UART (optional)	CH1 to CH8, Logic
	FlexRay (optional)	CH1 to CH8
	CAN (optional)	CH1 to CH8
	CAN FD (optional)	CH1 to CH8
	LIN (optional)	CH1 to CH8
	SENT (optional)	CH1 to CH8, Logic
	CXPI (optional)	CH1 to CH8
	User Define	CH1 to CH8
AB triggers	A Delay B	10 ns to 10 s
	A to B(n)	1 to 10 ⁹
Trigger level setting range	CH1 to CH8	± 4 div from center of screen
Trigger level setting resolution	CH1 to CH8	0.01 div (TV trigger: 0.1 div)
Trigger level accuracy ¹	CH1 to CH8	± 0.04 div

Display	
Display ²	12.1-inch TFT LCD with a capacitive touch screen, 1024 x 768 (XGA)

Functions	
Waveform acquisition modes	Normal, Envelope, Average
High Resolution mode	Max. 12 bit
Sampling modes	Real time, interpolation, repetitive
Accumulation	Select OFF, Intensity (waveform frequency by brightness), or Color (waveform frequency by color) Accumulation time: 100 ms to 100 s, Infinite
Roll mode	Enabled at 100 ms/div to 500 s/div (depending on the record length setting)
Zoom function	Two zooming windows can be set independently (Zoom1, Zoom2)
	Zoom factor $\times 2$ to 2.5 points/10 div (in zoom area)
	Scroll Auto Scroll
Search functions	Edge, Pulse Width, Timeout, Pattern, I ² C (optional), SPI (optional), UART (optional), CAN (optional), CAN FD (optional), LIN (optional), FlexRay (optional), SENT (optional), CXPI (optional), User Define
History memory	Max. data (record length 1.25 k Points, with) /M2 or /M2S: 100000, /M1 or /M1S: 50000, Standard: 20000
	History search Select Rect, Wave, Polygon, or Parameter mode
	Replay function Automatically displays the history waveforms sequentially
	Display Specified or average waveforms
Cursor	Types ΔT , ΔV , $\Delta T \ \& \ \Delta V$, Marker, Degree
Snapshot	Currently displayed waveform can be retained on screen

Computation and Analysis Functions	
Parameter Measurement	Max, Min, P-P, High, Low, Amplitude, Rms, Mean, Sdev, IntegTY+, IntegTY, +Over, -Over, Pulse Count, Edge Count, V1, V2, ΔT , Freq, Period, Avg Freq, Avg Period, Burst, Rise, Fall, +Width, -Width, Duty, Delay
Statistical computation of parameters	Max, Min, Mean, σ , Count
Statistics modes	Continuous, Cycle, History
Trend/Histogram display of wave parameters	Up to 2 trend or histogram display of specified wave parameters
Computations (MATH)	+, -, \times , Filter (Delay, Moving Avg, IIR Lowpass, IIR Highpass), Integ, Count (Edge, Rotary), user defined math (optional)
Computable no. of traces	8 (M1 to M8) (4 trace for 4 ch model) (mutually exclusive with REF trace)

Max. computable memory length	Same as the maximum record length
Reference function	Up to 8 traces (Ref1 to Ref8) of saved waveform data can be displayed and analyzed (4 trace for 4 ch model) (mutually exclusive with MATH trace)
Action-on-trigger	Actions: Buzzer, Print, Save, Mail
GO/NO-GO	Modes: Rect, Wave, Polygon, Parameter Actions: Buzzer, Print, Save, Mail
X-Y	Displays XY1 to XY4 and T-Y simultaneously (XY1, XY2 and T-Y for 4ch model)
FFT	Number of points: 1.25 k, 2.5k, 12.5 k, 25 k, 125 k, 250 k, 1.25 M Window functions: Rectangular, Hanning, Flat-Top FFT Types: PS (LS, RS, PSD, CS, TF, CH are available with /G02 option)
Histogram	Displays a histogram of acquired waveforms
User-defined math (/G02 option)	The following operators can be arbitrarily combined in equations: +, -, ×, /, SIN, COS, TAN, ASIN, ACOS, ATAN, INTEG, DIFF, ABS, SQRT, LOG, EXP, LN, BIN, DELAY, P2 (power of 2), PH, DA, MEAN, HLB, PWHH, PWLL, PWHL, PWLH, PWXX, FV, DUTYH, DUTYL, FILT1, FILT2 The maximum record length that can be computed is the same as the standard math functions.

Power supply analysis (/G03 option)	Selectable from 4 analysis types Deskweing between the voltage and current waveforms can be executed automatically.
Switching loss	Measurement of total loss and switching loss, power waveform display, Automatic measurement and statistical analysis of power analysis items (PTurn On, PTurn Off, POn, PTotal, WpTurn On, WpTurn Off, WpOn, WpTotal, Cycle Count)
Safety operation area	SOA analysis by X-Y display, using voltage as X axis, and current as Y axis is possible
Harmonic analysis	Basic comparison is possible with following standard Harmonic emission standard IEC61000-3-2 edition 4.0, EN61000-3-2 (2006), IEC61000-4-7 edition 2.1
Joule integral	Joule integral (I ² t) waveform display, automatic measurement and statistical analysis is possible

Power Measurement	Automated measurement of power parameters for up to four pairs of voltage and current waveforms. Values can be statistically processed and calculated. Measurement parameters Urms, Umn, Udc, Urmn, Uac, U+pk, U-pk, Up-p, lrms, lmn, ldc, lrmn, lac, l+pk, l-pk, lp-p, P, S, Q, Z, λ, Wp, Wp+, Wp-, Abs.Wp, q, q+, q-, Abs.q, Avg Freq (voltage, current)
-------------------	--

Common Features of Serial Bus Signal Analysis Functions

Analysis result display	Decoded information is displayed together with waveforms or in list form.
Auto setup function	A threshold value, time axis scale, voltage axis scale and other bus-specific parameters such as a bit rate and recessive level are automatically detected. Trigger conditions are set based on the detected result and decoded information is displayed. (The type of a bus signal needs to be specified in advance.)
Search function	Search of all waveforms for a position that matches a pattern or condition specified by data information.
Analysis result saving function	Analysis list data can be saved to CSV-format files.

PC Bus Signal Analysis Functions (/F01 Option)

Applicable bus	I ² C bus Bus transfer rate: 3.4 Mbit/s max. Address mode: 7 bit/10 bit SM bus Complies with System Management Bus
Analyzable signals	CH1 to CH8, Logic input, or M1 to M8
I ² C trigger modes	Every Start, Address & Data, NON ACK, General Call, Start Byte, HS Mode
Analyzable no. of data	300000 bytes max.
List display items	Analysis no., time from trigger position [Time (ms)], 1st byte address, 2nd byte address, R/W, Data, Presence/absence of ACK, information

SPI Bus Signal Analysis Functions (/F01 Option)

Trigger types	3 wire, 4 wire After assertion of CS, compares data after arbitrary byte count and triggers.
Analyzable signals	CH1 to CH8, Logic input, M1 to M8
Byte order	MSB, LSB
Analyzable no. of data	300000 bytes max.
List display items	Analysis no., time from trigger position [Time (ms)], Data 1, Data 2

UART Signal Analysis Functions (/F01 Option)

Bit rate	115200 bps, 57600 bps, 38400 bps, 19200 bps, 9600 bps, 4800 bps, 2400 bps, 1200 bps, User Define (an arbitrary bit rate from 1 k to 10 Mbps with resolution of 100 bps)
----------	---

Analyzable signals	CH1 to CH8, Logic input, or M1 to M8
Data format	Select a data format from the following 8 bit (Non Parity), 7 bit Data + Parity, 8 bit + Parity
UART trigger modes	Every Data, Data, Error
Analyzable no. of data	300000 bytes max.
List display items	Analysis no., time from trigger position [Time (ms)], Data (Bin, Hex) display, ASCII display, Information.

CAN Bus Signal Analysis Functions (/F02 Option)

Applicable bus	CAN version 2.0A/B, Hi-Speed CAN (ISO11898), Low-Speed CAN (ISO11519-2)
Analyzable signals	CH1 to CH8, M1 to M8
Bit rate	1 Mbps, 500 kbps, 250 kbps, 125 kbps, 83.3 kbps, 33.3 kbps, User Define (an arbitrary bit rate from 10 kbps to 1 Mbps with resolution of 100 bps)
CAN bus trigger modes	SOF, ID/Data, ID OR, Error, Message and signal (enabled when loading physical values/symbol definitions)
Analyzable no. of frames	100000 frames max.
List display items	Analysis no., time from trigger position [Time (ms)], Frame type, ID, DLC, Data, CRC, presence/absence of Ack, Information
Auxiliary analysis functions	Field jump functions

CAN FD Bus Signal Analysis Functions (/F02 Option)

Applicable bus	CAN FD (ISO 11898-1:2015 and non-ISO)
Analyzable signals	CH1 to CH8, M1 to M8
Bit rate	Arbitration 1 Mbps, 500 kbps, 250 kbps, User Define (an arbitrary bit rate from 20 kbps to 1 Mbps with resolution of 100 bps) Data 8 Mbps, 5 Mbps, 4 Mbps, 2 Mbps, 1 Mbps, 500 kbps, User Define (an arbitrary bit rate from 250 kbps to 10 Mbps with resolution of 100 bps)
CAN FD bus trigger modes	SOF, Error, ID/Data, ID OR, FDF, ESI, Message (enabled when loading physical values/symbol definitions)
Analyzable no. of frames	50000 frames max.
List display items	Analysis no., time from trigger position [Time (ms)], Frame type, ID, DLC, Data, CRC, presence/absence of Ack, Information
Auxiliary analysis functions	Field jump functions

LIN Bus Signal Analysis Functions (/F02 Option)

Applicable bus	LIN Rev. 1.3, 2.0, 2.1
Analyzable signals	CH1 to CH8, M1 to M8
Bit rate	19.2 kbps, 9.6 kbps, 4.8 kbps, 2.4 kbps, 1.2 kbps, User Define (an arbitrary bit rate from 1 kbps to 20 kbps with resolution of 10 bps)
LIN bus trigger modes	Break Synch, ID/Data, ID OR, Error
Analyzable no. of frames	100000 frames max.
List display items	Analysis no., time from trigger position [Time (ms)], ID, ID-Field, Data, Checksum, Information
Auxiliary analysis functions	Field jump functions

FlexRay Bus Signal Analysis Functions (/F03 Option)

Applicable bus	FlexRay Protocol Version 2.1
Analyzable signals	CH1 to CH8, M1 to M8
Bit rate	10 Mbps, 5 Mbps, 2.5 Mbps
FlexRay bus trigger modes	Frame Start, Error, ID/Data, ID OR
Analyzable no. of frames	5000 frames max.
List display items	Analysis no., time from trigger position [Time (ms)], Segment (Static or Dynamic), Indicator, FrameID, Payload length, Cycle count, Data, Information

SENT Signal Analysis Functions (/F04 Option)

Applicable standard	J2716 APR2016 and older
Analyzable signals	CH1 to CH8, Logic input, or M1 to M8
Clock period	1 μs to 100 μs with resolution of 0.01 μs
Data type	Fast channel Nibbles/User Defined Slow channel Short/Enhanced
SENT trigger modes	Every Fast CH, Fast CH Status & Communication, Fast CH Data, Every Slow CH, Slow CH ID/Data, Error
Analyzable no. of frames	100000 frames max.
List display items	Fast channel Analysis no., time from trigger position [Time (ms)], Sync/Cal period, Tick, Status & Comm, Data, CRC, frame length, Information Slow channel Analysis no., time from trigger position [Time (ms)], ID, Data, CRC, information
Auxiliary analysis functions	Trend functions (up to 4 trend waveforms)

CXPI Bus Signal Analysis Functions (/F05 Option)

Applicable bus	CXPI JASO D 015-3:2015
Analyzable signals	CH1 to CH8, M1 to M8

Bit rate	19.2 kbps, 9.6 kbps, 4.8 kbps, User Define (an arbitrary bit rate from 4 kbps to 50 kbps with resolution of 10 bps)
Analyzable no. of frames	10000 frames max.
List display items	Analysis no., time from trigger position [Time (ms)], ID, DLC, W/S, CT, Data, CRC, error information, Wakeup/Sleep

GP-IB (/C1 Option)

Electromechanical specifications	Conforms to IEEE std. 488-1978 (JIS C 1901-1987)
Protocol	Conforms to IEEE std. 488.2-1992

Auxiliary Input

Rear panel I/O signal	External trigger input, External trigger output, GO/NO-GO output, Video output
Probe interface terminal (front panel)	8 terminals (DLM50x8), 4 terminals (DLM50x4)
Probe power terminal (side panel)	8 terminals (/P8 option), 4 terminals (/P4 option)

Internal Storage (Standard model, /C8 Option)

Capacity	Standard model: Approx. 1.7 GB, /C8 option: Approx. 64 GB
----------	---

Built-in Printer (/B5 Option)

Built-in printer	112 mm wide, monochrome, thermal
------------------	----------------------------------

USB Peripheral Connection Terminal

Connector	USB type A connector × 2 (front panel × 2)
Electromechanical specifications	USB 2.0 compliant
Supported transfer standards	High Speed, Full Speed, Low Speed
Supported devices	USB Printer Class Ver. 1.0 compliant HP (PCL) inkjet printers, USB Mass Storage Class Ver. 1.1 compliant mass storage devices (Usable capacity: 8 TB, Partition format: GPT/MBR, File format: exFAT/FAT 32/FAT 16) * Please contact your local YOKOGAWA sales office for model names of verified devices

USB-PC Connection Terminal

Connector	USB type B connector × 1
Electromechanical specifications	USB 3.0 compliant
Supported transfer standards	Super Speed, High Speed, Full Speed
Supported class	Mass Storage Class Ver. 1.1 USBTCM-USB488 (USB Test and Measurement Class Ver. 1.0)

Ethernet

Connector	RJ-45 connector × 1
Transmission methods	Ethernet (1000BASE-T/100BASE-TX/10BASE-T)
Supported services	Server: FTP, VXI-11, Socket Client: FTP, SMTP, SNMP, LPR, DHCP, DNS

General Specifications

Rated supply voltage	100 to 120 VAC/220 to 240 VAC (Automatic switching)
Rated supply frequency	50 Hz/60 Hz
Maximum power consumption	290 VA
External dimensions	426 (W) × 266 (H) × 180 (D) mm (when printer cover is closed, excluding protrusions)
Weight	Approx. 7.3 kg, With no options
Operating temperature range	5°C to 40°C

*1: Measured under standard operating conditions after a 30-minute warm-up followed by calibration.

Standard operating conditions: Ambient temperature: 23°C±5°C, Ambient humidity: 55±10% RH
Error in supply voltage and frequency: Within 1% of rating

*2: Value in the case of repetitive phenomenon. The frequency bandwidth of a single-shot phenomenon is the smaller of the two values, DC to sampling frequency/2.5 or the frequency bandwidth of the repetitive phenomenon.

*3: When the input section is shorted, the acquisition mode is set to Normal, accumulation is OFF, and the probe attenuation is set to 1:1.

*4: The LCD may include a few defective pixels (within 3 ppm over the total number of pixels including RGB).

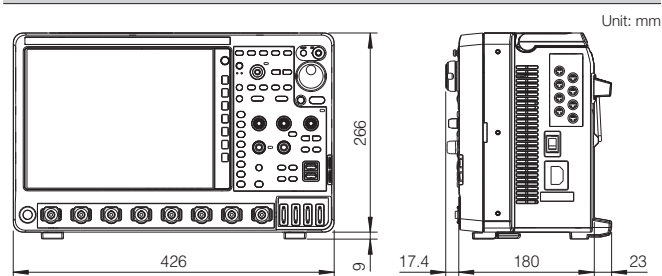
External Dimensions

Model and Suffix Codes

Model ¹	Suffix code	Description
DLM5038		Mixed Signal Oscilloscope: 8 ch, 350 MHz
DLM5058		Mixed Signal Oscilloscope: 8 ch, 500 MHz
DLM5034		Mixed Signal Oscilloscope: 4 ch, 350 MHz
DLM5054		Mixed Signal Oscilloscope: 4 ch, 500 MHz
Power cord	-D	UL/CSA Standard and PSE compliant
	-F	VDE/Korean Standard
	-Q	British Standard
	-R	Australian Standard
	-H	Chinese Standard
	-N	Brazilian Standard
	-T	Taiwanese Standard
	-B	Indian Standard
	-U	IEC Plug Type B
Language	-HJ	Japanese message and panel
	-HE	English message and panel
	-HC	Chinese message and panel
	-HG	German message and panel
	-HF	French message and panel
	-HK	Korean message and panel
	-HL	Italian message and panel
	-HS	Spanish message and panel
	Option	/L32
/B5		Built-in printer (112 mm)
/M1 ²		Memory expansion option (8 ch model only) During continuous measurement: 25 Mpoints; Single mode: 125 Mpoints/250 Mpoints ³
/M2 ²		Memory expansion option (8 ch model only) During continuous measurement: 50 Mpoints; Single mode: 250 Mpoints/500 Mpoints ³
/M1S ²		Memory expansion option (4 ch model only) During continuous measurement: 25 Mpoints; Single mode: 125 Mpoints/250 Mpoints ³
/M2S ²		Memory expansion option (4 ch model only) During continuous measurement: 50 Mpoints; Single mode: 250 Mpoints/500 Mpoints ³
/P8 ⁴		8 probe power terminals (for 8 ch model)
/P4 ⁴		4 probe power terminals (for 4 ch model)
/C1		GP-IB interface
/C8		Internal storage (64 GB)
/G02		User-defined math function
/G03		Power supply analysis function
/F01		UART + I ² C + SPI trigger and analysis
/F02		CAN + CAN FD + LIN trigger and analysis
/F03	FlexRay trigger and analysis	
/F04	SENT trigger and analysis	
/F05	CXPI trigger and analysis	
/E1 ⁵	Four additional 701937 probes (8 in total) (for 8 ch model)	
/E2 ⁵	Attach four 701949 probes	
/E3 ⁵	Attach eight 701949 probes (for 8 ch model)	

Standard Main Unit Accessories

Power cord, Passive probe⁶, Protective front cover, Panel sheet⁷, Soft carrying case for probes, Printer roll paper (for /B5 option), User's manuals⁸

- *1: Standard memory capacity: During continuous measurement: 12.5 Mpoints; Single mode: 50 Mpoints/125 Mpoints (when odd channels only)
Logic probes sold separately.
*2,*5: When selecting from these options, please select only one.
*3: When odd channels only
*4: Specify this option when using current probes or other differential probes that don't support probe interface.
*6: Four 701937 except /E2 or /E3.
*7: Except suffix code "-HE".
*8: Start guide as the printed material, and User's manual as CD-ROM are included.

Accessory Models

Name	Model	Specification
Logic probe (PBL100)	701988	1 MΩ, toggle freq. of 100 MHz
Logic probe (PBL250)	701989	100 kΩ, toggle freq. of 250 MHz
Passive probe ¹	701937	10 MΩ (10:1), 500 MHz, 1.3 m
Miniature passive probe	701949	10 MΩ (10:1), 500 MHz, 1.3 m
Passive probe (Wide temperature range)	702907	10 MΩ (10:1), 200 MHz, 2.5 m -40°C to +85°C
FET probe ¹	700939	DC to 900 MHz BW, 2.5 MΩ/1.8 pF
100:1 voltage probe	701944	DC to 400 MHz BW, 1.2 m, 1000 Vrms
100:1 voltage probe	701945	DC to 250 MHz BW, 3 m, 1000 Vrms
Differential probe	701920	DC to 500 MHz BW, max. ±12 V
Differential probe	701921	DC to 100 MHz BW, max. ±700 V
Differential probe	701922	DC to 200 MHz BW, max. ±20 V
Differential probe (PBDH1000)	701924	DC to 1 GHz BW, 1MΩ, max. ±25 V
Differential probe	701926	DC to 50 MHz BW, 7000 Vpeak
Differential probe (PBDH0150)	701927	DC to 150 MHz BW, max. ±1400 V
Differential probe	700924	DC to 100 MHz BW, max. ±1400 V
Differential probe	700925	DC to 15 MHz BW, max. ±500 V
Current probe ²	701917	DC to 50 MHz BW, 5 Arms
Current probe ²	701918	DC to 120 MHz BW, 5 Arms
Current probe (PBC050) ²	701929	DC to 50 MHz BW, 30 Arms
Current probe (PBC100) ²	701928	DC to 100 MHz BW, 30 Arms
Current probe ²	701930	DC to 10 MHz BW, 150 Arms
Current probe ²	701931	DC to 2 MHz BW, 500 Arms
Deskew correction signal source	701936	For deskew correction
Go/No-Go Cable	366973	For GO/NO-GO output terminal
Printer roll paper	B9988AE	Lot size is 10 rolls, 10 meters each
Probe stand	701919	Round base, 1 arm
Soft carrying case	701968	With 3 pockets for storage
Rack mount kit	701969-E	EIA standard-compliant
Rack mount kit	701969-J	JIS standard-compliant

*1: Please refer to the Probes and Accessories brochure for probe adapters.

*2: Current probes' maximum input current may be limited by the number of probes used at a time.

Accessory Software

Model	Name	Specification
701992-SP01	Xviewer	Standard edition
701992-GP01		Math edition

Additional Option License for DLM5000¹

Model	Suffix code	Description
709821	-G02	User defined math
	-G03	Power supply analysis function
	-F01	UART + I ² C + SPI trigger and analysis
	-F02	CAN + CAN FD + LIN trigger and analysis
	-F03	FlexRay trigger and analysis
	-F04	SENT trigger and analysis
	-F05	CXPI trigger and analysis

*1: Separately sold license product (customer-installable).

[DLM is a registered trademark of Yokogawa Electric Corporation.]

Any company's names and product names appearing in this document are the registered trademarks or trademarks of their respective companies.

NOTICE

- Before operating the product, read the user's manual thoroughly for proper and safe operation.

This is a Class A instrument based on Emission standards EN61326-1 and EN55011, and is designed for an industrial environment. Operation of this equipment in a residential area may cause radio interference, in which case users will be responsible for any interference which they cause.

YOKOGAWA

<https://tmi.yokogawa.com/>

YMI-KS-MI-SE07

YOKOGAWA TEST & MEASUREMENT CORPORATION

Global Sales Dept. /Phone: +81-422-52-6237 E-mail: tm@cs.jp.yokogawa.com
Facsimile: +81-422-52-6462

YOKOGAWA CORPORATION OF AMERICA

Phone: +1-800-888-6400 E-mail: tmi@us.yokogawa.com

YOKOGAWA EUROPE B.V.

Phone: +31-88-4641429 E-mail: tmi@nl.yokogawa.com

YOKOGAWA TEST & MEASUREMENT (SHANGHAI) CO., LTD.

Phone: +86-21-6239-6363 E-mail: tmi@cs.cn.yokogawa.com

YOKOGAWA ELECTRIC KOREA CO., LTD.

Phone: +82-2-2628-3810 E-mail: TMI@kr.yokogawa.com

YOKOGAWA ENGINEERING ASIA PTE. LTD.

Phone: +65-6241-9933 E-mail: TMI@sg.yokogawa.com

YOKOGAWA INDIA LTD.

Phone: +91-80-4158-6396 E-mail: tmi@in.yokogawa.com

YOKOGAWA ELECTRIC CIS LTD.

Phone: +7-495-737-78-68 E-mail: info@ru.yokogawa.com

YOKOGAWA AMERICA DO SUL LTDA.

Phone: +55-11-3513-1300 E-mail: tm@br.yokogawa.com

YOKOGAWA MIDDLE EAST & AFRICA B.S.C(c)

Phone: +973-17-358100 E-mail: help.ymatmi@bh.yokogawa.com Facsimile: +973-17-336100

The contents in this catalog is as of August 2020. Subject to change without notice.

Copyright © 2020, Yokogawa Test & Measurement Corporation

[Ed: 01/b]

Printed in Japan, 008(KP)